

High Light Output Projection System • Großbildschirm Projektions-System

# SX10000

---

***User's Manual • Bedienungshandbuch***

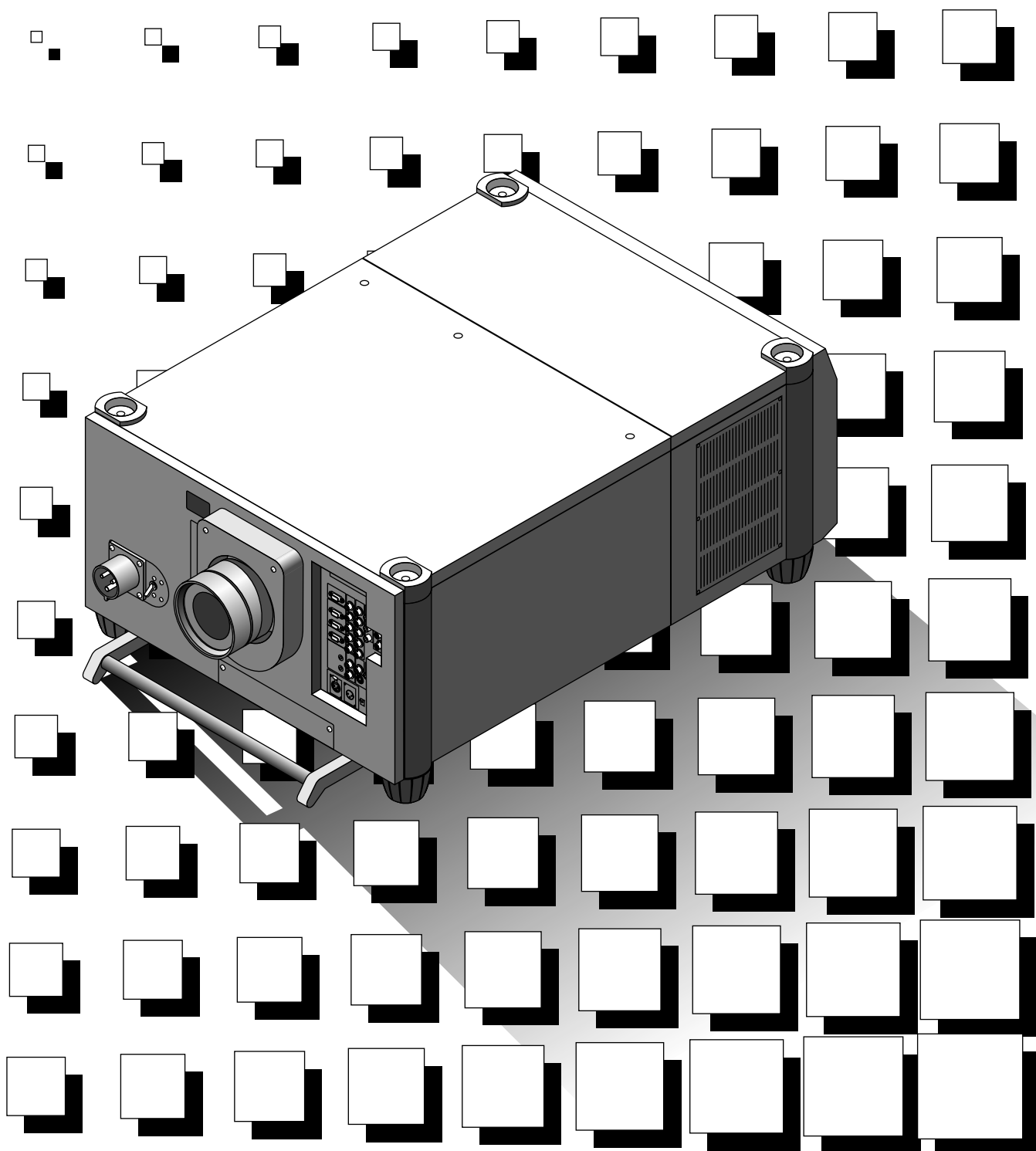

**NEC**

**SX10000**  
**High Light Output Projection System**

**User's Manual**

**CAUTION:** To turn off the main power, be sure to remove the plug from power outlet. The power outlet socket should be installed as near to the equipment as possible, and should be easily accessible.

**3. GSGV Acoustic Noise Information Ordinance:**

The sound pressure level is less than 70 dB(A) according to ISO 3744 or ISO 7779.

**WARNING**

TO PREVENT FIRE OR SHOCK HAZARDS, DO NOT EXPOSE THIS UNIT TO RAIN OR MOISTURE. ALSO DO NOT USE THIS UNIT'S POLARIZED PLUG WITH AN EXTENSION CORD RECEPTACLE OR OTHER OUTLETS, UNLESS THE PRONGS CAN BE FULLY INSERTED. REFRAIN FROM OPENING THE CABINET AS THERE ARE HIGH-VOLTAGE COMPONENTS INSIDE. REFER SERVICING TO QUALIFIED SERVICE PERSONNEL.

**Precautions:** Please read this manual carefully before using your NEC SX10000 Projector and keep the manual handy for future reference.

**WARNING**

This is a Class A product. In a domestic environment this product may cause radio interference in which case the user may be required to take adequate measures.

**AVERTISSEMENT**

POUR EVITER UN FEU OU UN RISQUE D'ELECTROCUTION NE PAS EXPOSER CET ENSEMBLE A LA PLUIE OU A L'HUMIDITE; DE MEME, NE PAS BRANCHER LA PRISE POLAIRE AVEC UNE RALLONGE A MOINS QUE LES DENTS DE LA PREMIERE NE S'Y INSERENT PLEINEMENT. EVITER D'OUVRIER LE COFFRET CAR IL Y A, A L'INTERIEUR, DES COMPOSANTS SOUMIS A UNE HAUTE-TENSION; POUR LES REPARATIONS, S'ADRESSER A UN PERSONNEL QUALIFIE.

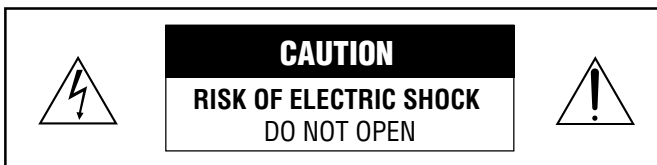

**CAUTION:** TO REDUCE THE RISK OF ELECTRIC SHOCK, DO NOT OPEN COVER. NO USER-SERVICEABLE PARTS INSIDE. REFER SERVICING TO QUALIFIED SERVICE PERSONNEL.

**ATTENTION:** POUR EVITER LES RISQUES D'ELECTROCUTION, NE PAS OUVRIR LE COUVERCLE. AUCUN DES ELEMENTS INTERNES NE DOIT ETRE REPARÉ PAR L'UTILISATEUR. NE CONFIER L'ENTRETIEN QU'A UN PERSONNEL QUALIFIE.



This symbol warns the user that uninsulated voltage within the unit may have sufficient magnitude to cause electric shock. Therefore, it is dangerous to make any kind of contact with any part inside of this unit.



L'éclair fléché dans un triangle équilatéral est destiné à avertir l'utilisateur de la présence, dans l'appareil, d'une zone non-isolée soumise à une haute-tension dont l'intensité est suffisante pour constituer un risque d'électrocution.



This symbol alerts the user that important literature concerning the operation and maintenance of this unit has been included. Therefore, it should be read carefully in order to avoid any problems.



Le point d'exclamation dans un triangle équilatéral est destiné à attirer l'attention de l'utilisateur sur la présence d'informations de fonctionnement et d'entretien importantes dans la brochure d'accompagnement l'appareil.

**DOC compliance Notice**

This Class A digital apparatus meets all requirements of the Canadian Interference-Causing Equipment Regulations.

**DOC avis de conformation**

Cet appareil numérique de la classe A respecte toutes les exigences du Règlement sur le Matériel D'interférence du Canada.

**CAUTION**

- \* In order to reduce any interference with radio and television reception use a signal cable with ferrite core attached. Use of signal cables without a ferrite core attached may cause interference with radio and television reception.
- \* This equipment has been tested and found to comply with the limits for a Class A digital device, pursuant to Part 15 of the FCC Rules. These limits are designed to provide reasonable protection against harmful interference when the equipment is operated in a commercial environment. This equipment generates, uses, and can radiate radio frequency energy and, if not installed and used in accordance with the installation manual, may cause harmful interference to radio communications. Operation of this equipment in a residential area is likely to cause harmful interference in which case the user will be required to correct the interference at his own expense.

## Important Safeguards

These safety instructions are to ensure the long life of your projector and to prevent fire and shock. Please read them carefully and heed all warnings.

### Installation

1. Place the projector on a flat, level surface and in a dry area free from dust and moisture.
2. Do not place the projector in direct sunlight, near heaters or heat radiating appliances.
3. Exposure to direct sunlight, smoke or steam could harm internal components.
4. Handle your projector carefully. Dropping or jarring your projector could damage internal components.
5. Do not place heavy objects on top of the projector.
6. If you wish to have the projector installed on the ceiling:
  - a Do not attempt to install the projector yourself.
  - b The projector must be installed by qualified technicians in order to ensure proper operation and reduce the risk of bodily injury.
  - c In addition, the ceiling must be strong enough to support the projector and the installation must be in accordance with any local building codes.
  - d Please consult your dealer for more information.
  - e Do not attempt to stack projectors on the ceiling.

### To Dealer or Installer:

To prevent the projector from falling, install it in a place and fasten it in a way with sufficient strength to support the combined weight (107 kg/236 lb) of the projector (84 kg/185.3 lb), the lens (10 kg/22 lb) and the ceiling mount (13 kg/28.7 lb) for an extended period of time as well as to withstand earthquakes.

### Power Supply

1. The projector is designed to operate on a power supply of 2.8 KW AC200-240V 50/60Hz. Ensure that your power supply fits this requirement before attempting to use your projector.
2. Handle the power cable carefully and avoid excessive bending. A damaged cord can cause electric shock or fire.
3. If the projector will not be used for an extended period of time, disconnect the plug from the power outlet.
4. Placing the power cord and the RGB cable closely to each other can cause beat noise. If this happens, keep the two separated so that beat noise is not generated.

### Cleaning

1. Unplug the projector before cleaning.
2. Clean the cabinet periodically with a damp cloth. If heavily soiled, use a mild detergent. Never use strong detergents or solvents such as alcohol or thinner.
3. Use a blower or lens paper to clean the lens, and be careful not to scratch or mar the lens.

## Fire and Shock Precautions

1. Ensure that there is sufficient ventilation and that vents are unobstructed to prevent potentially dangerous concentrations of ozone and the build-up of heat inside your projector. Allow at least 8 inches (20cm) of space between your projector and a wall. Allow at least 20 inches (50 cm) of space between the ventilation outlet and object.
2. Prevent foreign objects such as paper clips and bits of paper from falling into your projector. Do not attempt to retrieve any objects that might fall into your projector. Do not insert any metal objects such as a wire or screwdriver into your projector. If something should fall into your projector, disconnect it immediately and have the object removed by a qualified your service person.
3. Do not place any liquids on top of your projector.

**CAUTION:** High Pressure Lamp May Explode if Improperly Handled. Refer Servicing to Qualified Service Personnel.

### Lamp Caution: Please read before operation

Due to the lamp being sealed in a pressurized environment, there is a small risk of explosion, if not operated correctly. There is minimal risk involved, if the unit is in proper working order, but if damaged or operated beyond the recommended 750 hours, the risk of explosion increases.

Please note that there is a warning system built in, that displays the following message when you reach 750 hours of operation" Lamp Running Time is Over 750 Hours!!" When you see this message please contact your NEC Dealer for a replacement.

If the lamp does explode, smoke will be discharged from the vents located on the side of the unit. This smoke is comprised of glass in particulate form and Xenon gas, and will not cause harm if kept out of your eyes. If your eyes have been exposed to this gas, please flush your eyes out with water immediately and seek immediate medical attention. **Do not rub your eyes! This could cause serious injury.**

**WARNING:** Do not look into the lens while the projector is on. Serious damage to your eyes could result.

### CAUTION

Do not unplug the power cable from the wall outlet under any one of the following circumstances. Doing so can cause damage to the projector:

- While the message "Please wait a moment" appears. This message will be displayed after the projector is turned off.
- Immediately after the power cable is plugged into the wall outlet (the POWER indicator has not changed to a steady orange glow).
- Immediately after the cooling fan stops working (After the projector is turned off with the POWER OFF button the cooling fan continues to work for 3 minutes while the Two Digit INDICATOR "--" flashes).

## Recommandations importantes

Ces instructions de sécurité ont pour but d'assurer une longue vie à votre projecteur et d'éviter un incendie ou une décharge électrique. Prière de les lire avec attention et de tenir compte de tous les avertissements.

### Installation

1. Placer le projecteur sur une surface plate et de niveau, et dans un endroit sec et à l'abri des poussières et de l'humidité.
2. Ne pas exposer le projecteur aux rayons directs du soleil, ni le placer près d'un chauffage ou de dispositifs de radiation de chaleur.
3. L'exposition aux rayons directs du soleil, à la fumée ou à la vapeur pourrait endommager des composants internes.
4. Manipuler le projecteur avec précautions. Laisser tomber le projecteur ou lui donner des chocs pourrait endommager des composants internes.
5. Ne pas poser d'objets lourds sur le dessus du projecteur.
6. Si vous voulez installer le projecteur au plafond:
  - a. N'essayez pas d'installer le projecteur vous-même.
  - b. Le projecteur doit être installé par un technicien qualifié pour garantir une installation réussie et réduire le risque d'éventuelles blessures corporelles.
  - c. De plus le plafond doit être suffisamment solide pour supporter le projecteur et l'installation doit être conforme aux réglementations locales de construction.
  - d. Veuillez consulter votre revendeur pour de plus amples informations.
  - e. Ne pas superposer les projecteurs accrochés au plafond.

### A l'attention du revendeur ou de l'installateur:

Afin d'empêcher une chute éventuelle du projecteur, veuillez prendre en compte lors de son placement et de sa fixation de la force nécessaire pour supporter le poids total (107 kg), celui du projecteur (84 kg), de l'objectif (10 kg) et de l'ensemble de fixation au plafond (13 kg), pour de longues périodes et de façon à lui permettre de résister aux tremblements de terre.

### Alimentation

1. Le projecteur est conçu pour fonctionner sous une tension d'alimentation de 2,8 KW CA 200-240 V 50/60 Hz. S'assurer que la tension du secteur soit conforme à ces caractéristiques avant d'utiliser le projecteur.
2. Manipuler le cordon d'alimentation avec précautions et éviter des flexions excessives. Un cordon endommagé peut occasionner une décharge électrique ou un incendie.
3. Si le projecteur ne doit pas être utilisé pendant une longue période, débrancher la fiche de la prise de courant.
4. Placer le cordon d'alimentation et le câble RGB tout près l'un de l'autre peut occasionner un bruit de battement. Si cela se produit, les maintenir séparés jusqu'à ce que le bruit de battement disparaisse.

### Nettoyage

1. Débrancher le projecteur avant de le nettoyer.
2. Nettoyer régulièrement le boîtier extérieur avec un chiffon humide. S'il est très sale, utiliser un détergent doux. Ne jamais utiliser de détergent forts ou de solvants tels que de l'alcool ou du diluant.
3. Utiliser un souffleur ou du papier pour objectif pour nettoyer l'objectif, et faire attention de ne pas griffer ou endommager l'objectif.

## Précautions contre l'incendie ou la décharge

1. S'assurer qu'il y ait une ventilation suffisante et que les ouvertures ne soient pas obstruées afin d'éviter des concentrations potentiellement dangereuses d'ozone et l'accumulation de chaleur à l'intérieur du projecteur. Laisser au moins 20 cm d'espace entre le projecteur et un mur. Veuillez laisser un espace libre d'au moins 50 cm (20 pouces) entre les orifices de ventilation et l'objet.
2. Empêcher tous objets étrangers tels que des attaches trombones ou des morceaux de papier de tomber à l'intérieur du projecteur. Ne pas essayer de récupérer des objets qui seraient tombés dans le projecteur. Ne pas introduire d'objets métalliques tels qu'un fil ou un tournevis dans le projecteur. Si quelque-chose doit tomber dans le projecteur, le débrancher immédiatement et faire enlever l'objet par un technicien agréé NEC.
3. Ne pas poser de liquides sur le dessus du projecteur.

**ATTENTION:** La lampe à haute pression peut exploser si elle est manipulée incorrectement. Confier l'entretien à du personnel d'entretien qualifié.

### Précautions avec la lampe : lire avant l'utilisation

La lampe a été scellée dans un environnement sous pression, et il y a donc un petit risque d'explosion, si elle n'est pas utilisée correctement. Le risque est minime si l'appareil est en bon ordre de marche, mais s'il est endommagé ou utilisé au-delà des 750 heures recommandées, le risque d'explosion augmente alors.

Il est à noter l'existence d'un système d'avertissement intégré, lequel affiche le message "Lamp Running Time is Over 750 Hours!! (Le temps de fonctionnement de la lampe a dépassé 750 heures !!)" lorsque les 750 heures de fonctionnement sont atteintes. Lorsque ce message apparaît, prière de contacter son revendeur NEC pour un remplacement.

Si la lampe explose, de la fumée peut être produite par les fentes d'aération situées sur le côté de l'appareil. Cette fumée est composée de verre sous forme de particules et de gaz de Xenon, et n'est pas nuisible si elle est maintenue à distance des yeux. Si les yeux sont exposés à ce gaz, les rincer immédiatement à l'eau courante et consulter tout de suite un médecin. **Ne pas frotter les yeux ! Cela pourrait provoquer une grave blessure.**

### AVERTISSEMENT:

Ne pas regarder dans l'objectif lorsque le projecteur est allumé. De sérieux dommages aux yeux pourraient en résulter.

### ATTENTION

Ne pas débrancher le câble d'alimentation de la prise du secteur dans les circonstances suivantes car cela risque d'endommager le projecteur:

- Lorsque le message "Veuillez patientez un instant" apparaît. Ce message sera affiché après que le projecteur soit éteint.
- Immédiatement après que le cordon d'alimentation électrique ait été branché sur la prise du mur (l'indicateur POWER n'est pas encore devenu orange).
- Immédiatement après que le ventilateur de refroidissement de soit arrêté de fonctionner. (Après que le projecteur ait été mis hors tension à l'aide du bouton POWER OFF, le ventilateur d'aération continue à tourner durant 3 minutes tandis que le INDICATOR à deux chiffres "--" clignote).

# LIMITED WARRANTY (USA and Canada only)

---

NEC Technologies, Inc. (hereafter NECTECH) warrants this product to be free from defects in material and workmanship under the following terms.

## HOW LONG IS THE WARRANTY

Parts and labor are warranted for (1) One Year from the date of the first customer purchase. The lamp is warranted for 500 hours of operating time or 90 days, whichever comes first.

Decrease in lamp light output level is not covered by this warranty.

## WHO IS PROTECTED

This warranty may be enforced only by the first purchaser.

## WHAT IS COVERED AND WHAT IS NOT COVERED

Except as specified below, this warranty covers all defects in material or workmanship in this product. The following are not covered by the warranty:

1. Any product which is not distributed in the U.S.A. or Canada by NECTECH or which is not purchased in the U.S.A. or Canada, from an authorized NECTECH dealer.  
If you are uncertain as to whether a dealer is authorized, please contact NECTECH at 800-836-0655.
2. Any product on which the serial number has been defaced, modified or removed.
3. Damage, deterioration or malfunction resulting from:
  - a. Accident, misuse, abuse, neglect, fire, water, lightning or other acts of nature, unauthorized product modification, or failure to follow instructions supplied with the product.
  - b. Repair or attempted repair by anyone not authorized by NECTECH.
  - c. Any shipment of the product (claims must be presented to the carrier).
  - d. Removal or installation of the product.
  - e. Any other cause which does not relate to a product defect.
4. Cartons, batteries, external cabinets, magnetic tapes, or any accessories used in connection with the product.

## WHAT NEC WILL COVER

We will pay labor and material expenses for covered items, but we will not pay for the following:

1. Removal or installation charges.
2. Costs of initial technical adjustments (set-up), including adjustment of user controls. These costs are the responsibility of the NECTECH dealer from whom the product was purchased.
3. Payment of shipping charges.

## HOW YOU CAN GET WARRANTY SERVICE

1. To obtain service on your product, consult the dealer from whom you purchased the product, or ship it prepaid to any authorized NECTECH service center.
2. Whenever warranty service is required, the original dated invoice (or a copy) must be presented as proof of warranty coverage, and should be included in any shipment of the product. Please also include in any mailing, your name, address and a description of the problem(s).
3. For the name of the nearest NECTECH authorized service center, call NECTECH at 800-836-0655.

## LIMITATION OF IMPLIED WARRANTIES

All implied warranties, including warranties of merchantability and fitness for a particular purpose, are limited in duration to the length of this warranty.

## EXCLUSION OF DAMAGES

NECTECH's liability for any defective product is limited to the repair or replacement of the product at our option. NECTECH shall not be liable for:

1. Damage to other property caused by any defects in this product, damages based upon inconvenience, loss of use of the product, loss of time, commercial loss; or
2. Any other damages whether incidental, consequential or otherwise. Some states do not allow limitation on how long an implied warranty lasts and/or do not allow the exclusion or limitation of incidental or consequential damages, so the above limitations and exclusions may not apply to you.

## HOW STATE LAW RELATES TO THE WARRANTY

This warranty gives you specific legal rights, and you may also have other rights which vary from state to state.

FOR MORE INFORMATION, TELEPHONE 800-836-0655  
NEC TECHNOLOGIES, INC.  
1250 N. Arlington Heights Road, Suite 500  
Itasca, Illinois 60143-1248

---

**NOTE:** All products returned to NECTECH for service **MUST** have prior approval. To get approval, call NEC Technologies at 800-836-0655.

---

# TABLE OF CONTENTS

## INTRODUCTION

Introduction to the SX10000 Projector .....	E-1
Getting Started .....	E-1
What's in the Box? .....	E-1

## 1. PART NAMES AND FUNCTIONS

Projector .....	E-2
Controls .....	E-3
Terminal Panel .....	E-4
Remote Control .....	E-6
Remote Control Features .....	E-6
Remote Control Precautions .....	E-7
Remote Control Battery Installation .....	E-7

## 2. INSTALLATION

Setting up Your Projector .....	E-8
Screen Size and Projection Distance .....	E-8
Table of Throw Distance and Image Sizes for Optional Lenses .....	E-8
Lens Shift Adjustable Range .....	E-9
Moving the Projector .....	E-10
Selecting a Location .....	E-10

## 3. SETUP

Connecting the Power Cable and Turning on the Projector .....	E-11
About Startup Screen .....	E-12
Setting up the Projector .....	E-13
Keystone .....	E-14
Setting up for Double Stacking in Link Mode .....	E-14
Projector Orientation .....	E-16

## 4. CONNECTIONS

When Used in Standalone Operation .....	E-17
When Used with One Switcher (ISS-6020/ISS-6020G) .....	E-18
When Used with Two or More Switchers (100 Inputs) .....	E-19
REMOTE 1 Connector .....	E-21
Operating Multiple Projectors with the Remote Control .....	E-23
Using the RGB DIGITAL Connectors .....	E-24

## 5. OPERATION

General Controls .....	E-25
Using the Menus .....	E-25
Shutter Mechanism .....	E-25
Customizing Basic/Custom Menu .....	E-26
A List of Direct Key Combinations .....	E-27
Menu Tree .....	E-28
Menu Elements .....	E-30
Menu Descriptions & Functions .....	E-31
Source Select .....	E-31
Switcher .....	E-31
Entry List .....	E-31
Entry Edit Command .....	E-31
Adjust (Source) .....	E-32
Picture .....	E-32
Brightness .....	E-32
Contrast .....	E-32
Saturation .....	E-32
Color .....	E-32
Hue .....	E-32
Sharpness .....	E-32
V-Aperture .....	E-32
Gamma Correction .....	E-32
White Balance .....	E-32
Color Temperature .....	E-32
Brightness .....	E-32
Contrast .....	E-32
Signal Level .....	E-32
Image .....	E-32
Pixel Adjust .....	E-32
Clock/Phase .....	E-32
Horizontal/Vertical Position .....	E-33
Aspect Ratio .....	E-33
Resolution .....	E-33
Overscan .....	E-33
Video Filter .....	E-33
Blanking .....	E-33

Video Adj .....	E-33
Noise Reduction .....	E-33
Color Matrix .....	E-34
Y/C Delay .....	E-34
Telecine .....	E-34
Motion Select .....	E-34
Motion Level .....	E-34
YTR Adjustment .....	E-34
CTR Adjustment .....	E-34
Option Adj .....	E-34
Clamp Timing .....	E-34
Sync Protection .....	E-34
VD Delay .....	E-34
Lens Memory .....	E-35
Signal Type .....	E-35
Switcher .....	E-35
Gain .....	E-35
Volume .....	E-35
Ref Adj .....	E-35
Keystone .....	E-35
Lamp .....	E-36
Lamp Mode .....	E-36
Reference White Balance .....	E-36
Factory Default .....	E-36
Projector Options .....	E-36
Timer .....	E-36
On/Off Timer .....	E-36
Sleep Timer .....	E-37
Menu .....	E-37
Menu Mode/Language/Menu Display Time/ Display Select/Date Format/Date, Time Preset .....	E-37
Setup .....	E-38
Page 1: Orientation/Background/S-Video Mode Select .....	E-38
Page 2: Signal Select(RGB1/2) /Sync Termination (RGB 1/2) .....	E-38
Page 3: Signal Select (Video 1/2, S-Video 1/2 and Switcher) .....	E-38
Page 4: Auto Adjust (RGB Only) .....	E-38
Power Management/Power Off Confirmation ... ..	E-39
Keystone Save/Doubler/Last Memory/ Seamless/Lens Memory/User Name .....	E-39
Page 5: Communication Speed/Projector ID / Default Source Select .....	E-39
Link Mode .....	E-39
Switcher Control .....	E-39
Help .....	E-40
Contents .....	E-40
Source Information .....	E-40
Projector Information .....	E-40
Test Pattern .....	E-40
Selecting a new signal that is close to one of the listed signals in horizontal and vertical frequency .....	E-41

## 6. SPECIFICATIONS ..... E-42

## 7. Optional Accessories ..... E-44

XT SDI BOARD/SX HDSI BOARD .....	E-44
REMOTE 3 (XLR) Pin Assignments and Signals .....	E-44

## 8. Compatible Input Signal List ..... E-45

## 9. List of Menu Items Available in Link Mode ..... E-46

## Appendix ..... E-47

Dimensions .....	E-47
Tips on Adjusting Focus for Lens Memory Function .....	E-48

# INTRODUCTION

---

This section introduces you to your new SX10000 Projector, provides a list of materials that comes with your projector and describes the features and controls.

## Introduction to the SX10000 Projector

The SX10000 is one of the finest, most technically advanced projectors available today. The SX10000 enables you to project exceptionally bright, precise images up to 500 inches across (measured diagonally) from your PC or Macintosh computer (desktop or notebook), VCR, document camera, laser disc player, DVD player and even an HD VCR or HD laser disc player.

You can use the projector on a tabletop or cart, you can permanently mount it on a ceiling\*, or you can use the projector to project images from behind the screen. The remote control can be used in a wired or wireless configuration.

### Features you'll enjoy :

- A high-performance 2.0 KW Xenon lamp that delivers 8000 ANSI lumens with a lamp life of 750 hours.
- NEC's unique DLP™ based light engine offers true color reproduction.
- The SX10000 can accommodate any picture size from 80 to 500 inches (measured diagonally).
- The SX10000 projects images with uniform brightness while colors remain true to their original source.
- The projector can be double stacked without an external frame, producing bright images of 16,000 ANSI lumens. In addition, double stacking offers built-in redundancy.
- An image can be projected from in front or behind a screen, and the projector can even be installed on the ceiling\*.
- Supports RGB digital, HDTV and DVD signals as well as most IBM VGA, S-VGA, XGA, SXGA, UXGA (scaling), Macintosh or any other RGB signals within a horizontal frequency range of 15 to 107 kHz and a vertical frequency range of 24 to 105 Hz. This includes NTSC3.58, PAL, PAL60, SECAM, NTSC4.43, Y/C and 1080p, 1080i, 720p and 480p HDTV standard video signals.
- Built-in telecine detection enables 3:2 pull-down correction with no external processing necessary, eliminating jitter and artifacts to allow for original film source motion quality.
- A newly designed menu system provides for easy setup and operation of the projector.
- The remote control can be used wired or wireless.

\* Installing the projector on the ceiling must be done by authorized NEC technicians.  
Consult your NEC dealer for more information.

Digital Light Processing and DLP are trademarks of Texas Instruments.

## Getting Started

The fastest way to get started is to take your time and do everything right the first time. Taking a few minutes now to review the manual may save you hours later on. At the beginning of each section of the manual you'll find an overview. If the section doesn't apply, you can skip it.

## What's In The Box?

Make sure your box contains everything listed. If any pieces are missing, contact your dealer. Please save the original box and packing materials if you ever need to ship the projector.

- SX10000 Projector
- Remote Control with Remote Cable (wireless/wired)
- DVI-D Cable
- Ferrite clamp core for DVI-D cable
- RGB signal cable (15-pin D-Sub)
- Power Cable (single phase)
- Two AA Batteries
- User Manual
- CompactFlash Memory Card (8MB) with Adapter



# 1. Part Names and Functions

## Projector

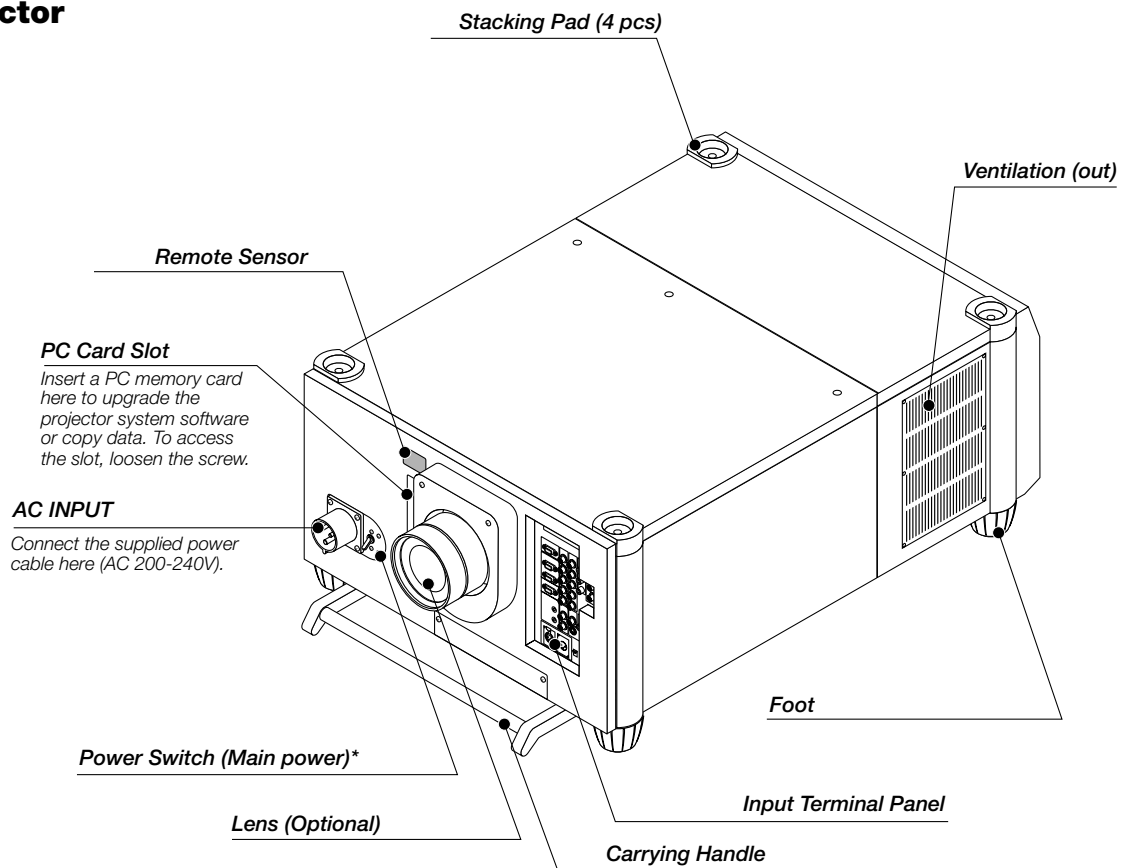

\* To turn on the main power to the projector, press the switch to the ON position (I) and the POWER indicator on the rear panel will turn orange in color. Press to the OFF position (O) to turn the main power off.

**NOTE:** When turning off the main power, first return the projector to the standby condition by pressing the POWER OFF button on the remote control or the POWER button on the rear panel and then turn off the main POWER switch. These procedures are necessary to protect your projector and the connected equipment.

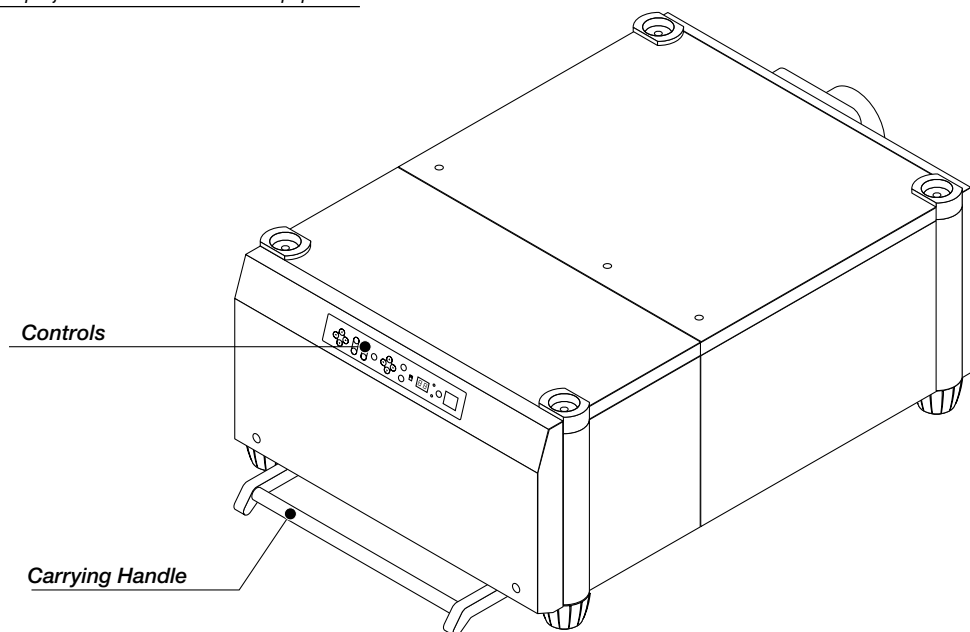

## Controls

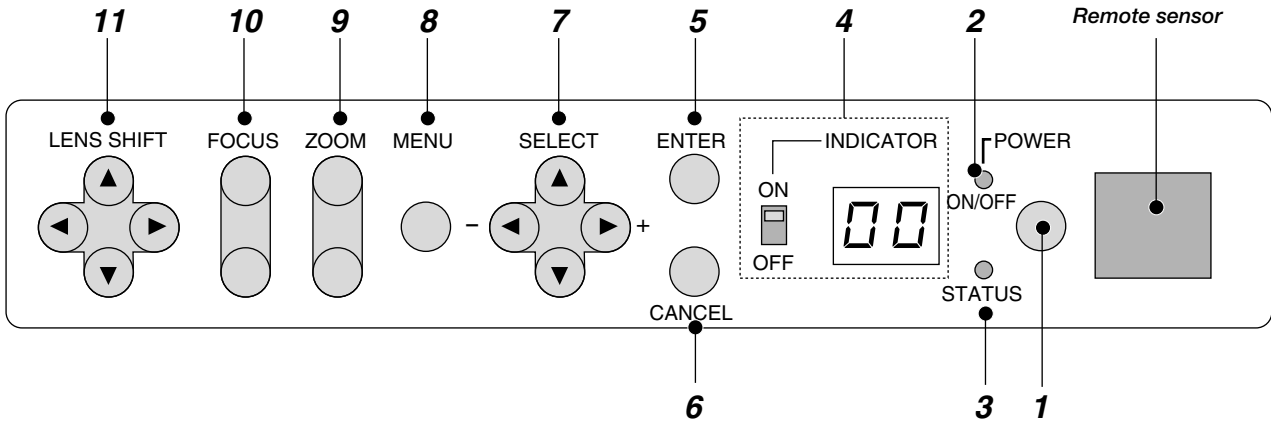

### 1. Power Button

Press to turn the projector on when the projector is in the standby condition (Main Power switch must be on and the POWER indicator lit orange). Press and hold for 2 seconds to turn off the projector.

### 2. Power Indicator

When this indicator is green, the projector is on; when the indicator is orange, it is in standby mode.

**NOTE:** After the projector is turned off, the indicator "--" flashes for three minutes to show that the cooling fan is working.

Do not turn off the main power during that time. After "--" stops flashing, the POWER indicator will change to a steady orange glow and the projector will be in the stand-by mode.

### 3. Status Indicator

When the On Timer is set and the projector is in the standby mode, the Status indicator flashes green to show that the On Timer program is active.

### 4. Two Digit Display

During normal operation the current projector ID (address) is shown in this two digit display. In the event of an error, a projector error code will be displayed. The display can be turned off using the ON/OFF Switch to the left of the display.

### 5. Enter Button

Executes your menu selection and activates items selected from the menu. When the sidebar or dialog box is displayed: Pressing this button confirms adjustments/setting and returns to the previous menu display.

### 6. Cancel Button

Press this button to exit the menu. Press this button to return the adjustments to the last condition while you are in the adjustment or setting menu.

### 7. Select (Up/Down/Left/Right) Button

Up/Down: Use these buttons to select the menu of the item you wish to adjust.

Left/Right: Use these buttons to change the level of a selected menu item.

### 8. Menu Button

Displays the main menu for operation.

### 9. Zoom Button

Zoom the lens in and out.

### 10. Focus Button

Adjust the lens focus.

### 11. Lens Shift Button

Adjust the lens offset by shifting the projected image position horizontally and vertically.

# Terminal Panel

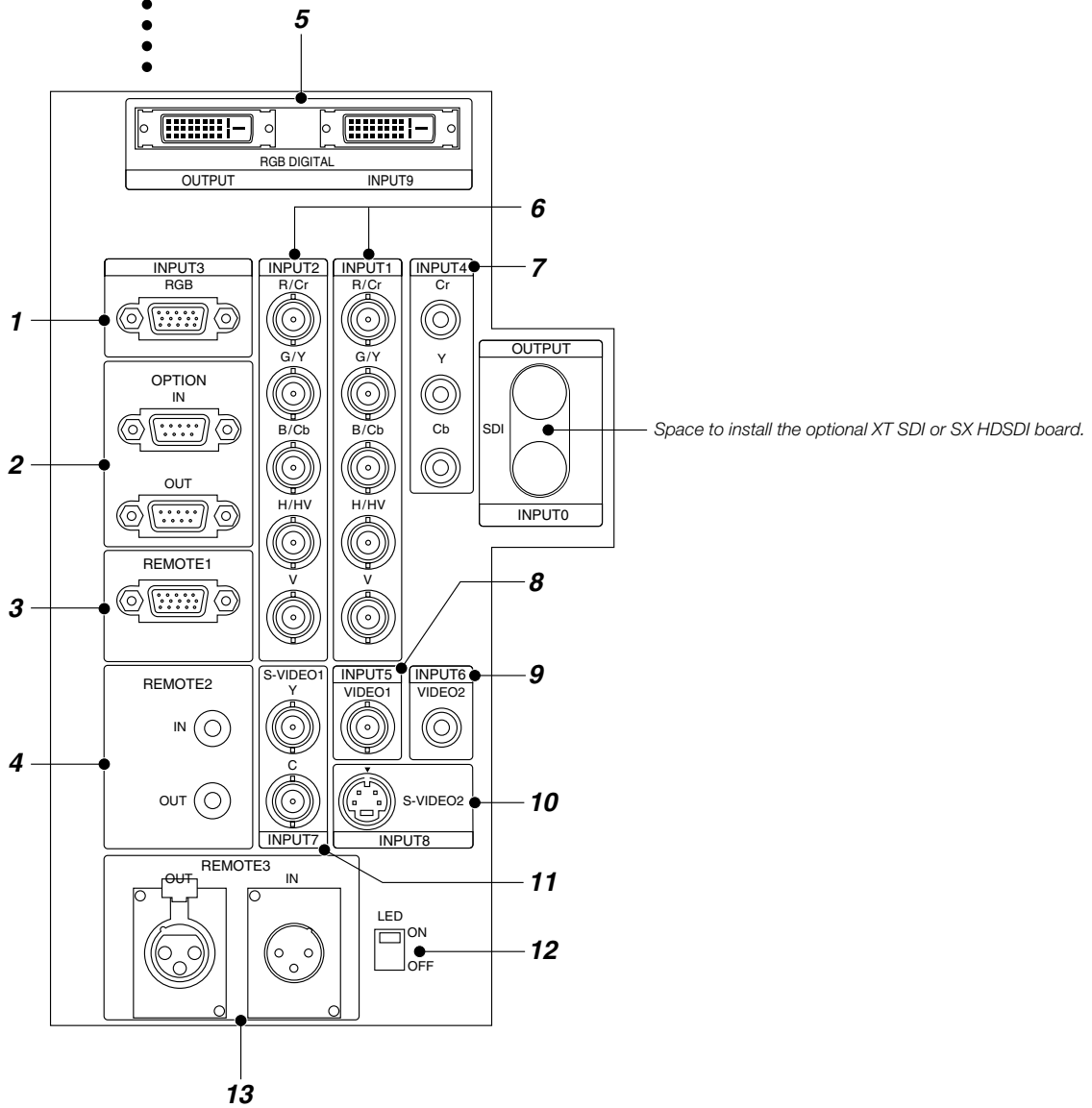
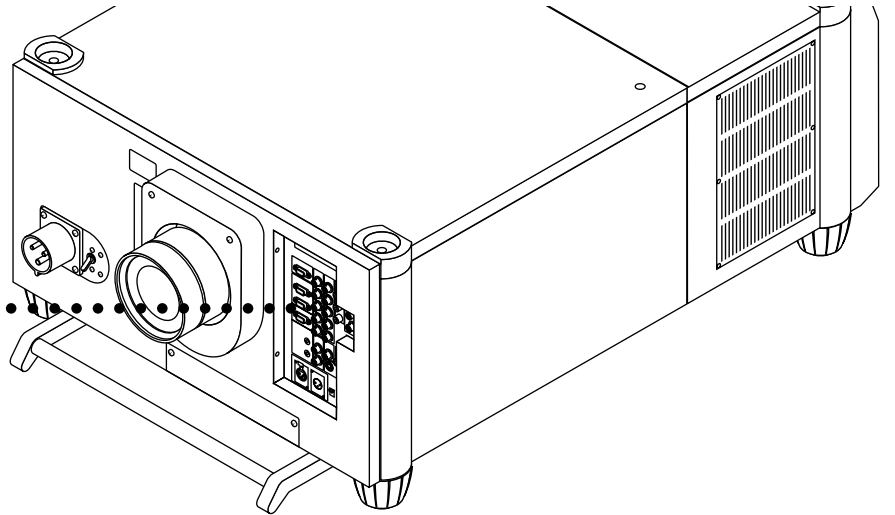

---

### 1. INPUT 3 RGB Connector (Mini D-Sub 15 pin)

Connect your PC or other analog RGB equipment such as a high-definition document camera.

This connector accepts RGB signals only.

Not compatible with component signals.

### 2. Option Connector (Mini D-Sub 9 pin)

For system expansion such as PC-control.

IN ..... connect to the external equipment such as PC or Third Party Control System.

OUT ..... for daisy-chaining multiple projectors and operating them with the same external equipment. To do so, connect to a second projector's IN terminal to relay the input at the IN terminal of the first projector until all the projectors are connected.

### 3. REMOTE 1 Connector (Mini D-Sub 15 pin)

This terminal allows external control of the projector from either the Switcher or from an external control. When the Switcher is used, connect to the REMOTE 1 terminal on the back of the Switcher.

---

**NOTE:** *This projector is compatible with the ISS-6020 Switcher.*

---

### 4. REMOTE 2 Jacks

IN ..... wired remote control input.

OUT ..... for daisy-chaining multiple projectors and operating them with the same remote control. To do so, connect to a second projector's IN terminal to relay the input at the IN terminal of the first projector until all the projectors are connected.

### 5. RGB Digital Input/Output Connectors (DVI-D 24 pin)

These connectors are used for double stacking.

Use the supplied DVI-D cable to connect the OUTPUT terminal of the first projector to the second projector's INPUT until all the projectors are connected.

The output is TMDS non-perfect.

The output connector is used for stacking.

### 6. INPUT 1 and INPUT 2 Terminals (BNC)

Connect R,G,B,H (Horizontal sync) and V (Vertical sync) outputs of the external equipment such as the Switcher. If using a component with a combined sync (SYNC) output, connect it to the H/V terminal.

Also connect component video outputs (Y/Cb/Cr) of the external equipment such as DVD player.

---

**NOTE:** *The INPUT 2 terminal does not support SW1 Level and SW2 Level modes for the ISS-6020 switcher.*

---

### 7. INPUT 4 Y/Cb/Cr Terminal (RCA)

Connect component video outputs (Y/Cb/Cr, Y/Pb/Pr) of the external equipment such as DVD player.

---

**NOTE:** *This terminal accepts component signals only.*

---

### 8. INPUT 5 VIDEO 1 Terminal (BNC)

Connect to the BNC video output of the external equipment such as a VCR or laser disc player.

### 9. INPUT 6 VIDEO 2 Terminal (RCA)

Connect to the RCA video output of the external equipment such as a VCR or laser disc player.

### 10. INPUT 8 S-VIDEO 2 Terminal (Mini DIN 4 pin)

Connect to the S-video output of the external equipment such as a VCR with an S-video output. This terminal allows switching between S2 and S1 VIDEO input modes. See the "S-Video Mode Select" section on page E-38 for more information.

### 11. INPUT 7 S-VIDEO 1 Terminal (BNC)

Connect to the Y/C separate BNC video outputs of the external equipment such as a VCR or laser disc player.

### 12. LED Switch

Lights up the panel on both the front and the rear at the same time.

### 13. REMOTE3 Connectors (XLR Connectors)

Connect an extension cable such as an audio cable to control two projectors or more using the remote control. See page E-43 for the pin assignments.

IN ..... wired remote control input.

OUT ..... for daisy-chaining multiple projectors and operating them with the same remote control. To do so, connect to a second projector's IN terminal to relay the input at the IN terminal of the first projector until all the projectors are connected.

# Remote Control

## Remote Control Features

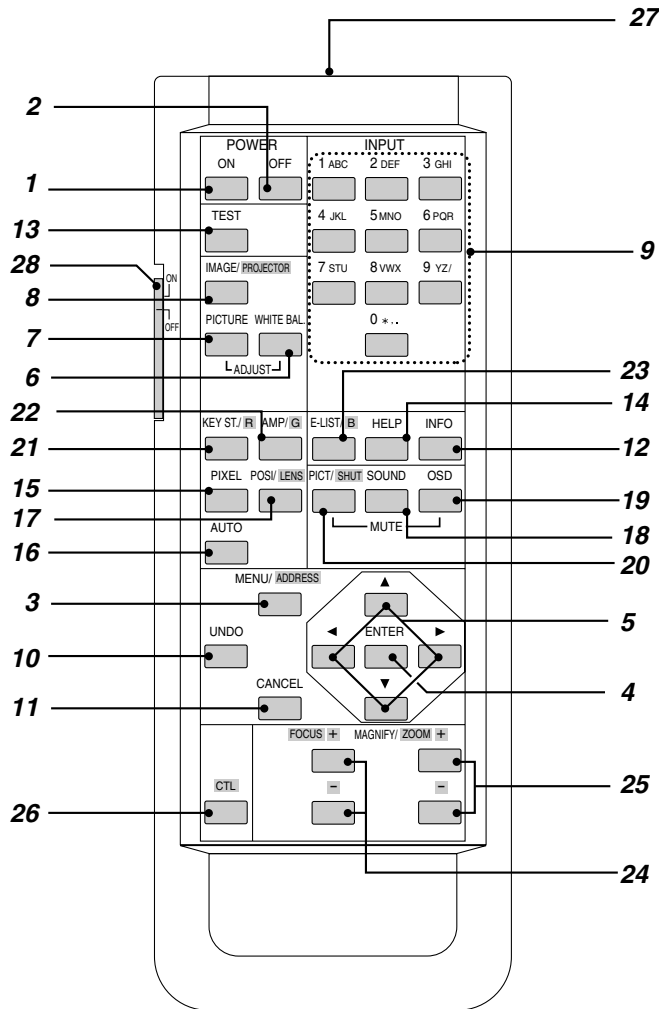

### 1 POWER ON

Press to turn on the projector. The POWER indicator lights up green.

### 2 POWER OFF

Press and hold this button for a minimum of two seconds to turn off the projector.

### 3 MENU

Press to display the main menu. While pressing and holding CTL, press this button to display the Remote Control ID dialog box to specify the remote control ID.

### 4 ENTER

Executes the menu selection and activates items selected from the menu. When the sidebar or dialog box is displayed: Pressing this button confirms adjustments/setting and returns to the previous menu display.

### 5 SELECT (Up/Down/Left/Right)

When pressed together, the CTL and ◀ buttons work as a Back Space key in the entry screen. Pressing and holding CTL, then this button moves the menu, sidebar or dialog box.

### 6 ADJUST WHITE BAL

Press to display the Color adjustment screen. Pressing this button sequentially selects "Color Temperature" → "White Balance - Brightness" → "White Balance - Contrast" → "Signal Level" → "Ref.White Bal" → "Switcher-Gain".

### 7 ADJUST PICTURE

Press to display the Picture adjustment screen. Pressing this button sequentially selects "Brightness" → "Contrast" → "Saturation" → "Color" → "Hue" → "Sharpness" → "V-Aperture" → "Gamma Correction".

### 8 IMAGE/PROJECTOR

Press to display the Image Option screen. Pressing this button sequentially selects "Pixel Adjust" → "Position" → "Aspect Ratio" → "Resolution" → "Overscan" → "Video Filter" → "Blanking".

While pressing and holding CTL, pressing this button rotates "On/Off Timer" → "Sleep Timer" → "Menu" → "Setup" → "Link Mode" → "Switcher Control".

### 9 INPUT

Use to select an input, to name a signal, or to enter a passcode during input registration.

- 1--INPUT 1 for RGBHV/Y, Cb/Pb, Cr/Pr
- 2--INPUT 2 for RGBHV/Y, Cb/Pb, Cr/Pr
- 3--INPUT 3 for RGB
- 4--INPUT 4 for Y, Cb/Pb, Cr/Pr
- 5--INPUT 5 for VIDEO 1
- 6--INPUT 6 for VIDEO 2
- 7--INPUT 7 for S-VIDEO 1
- 8--INPUT 8 for S-VIDEO 2
- 9--INPUT 9 for RGB DIGITAL input
- 0--INPUT 0 for SDI input on the optional SDI board

### 10 UNDO

Press to return the adjustments and settings to the previous condition. While pressing and holding CTL, pressing this button clears all the menus or adjustment/setting screen. At this time the adjustments/settings are stored in memory.

### 11 CANCEL

Press to exit the menu. Press this button with CTL to return to the previous menu while the menus appear. This feature allows you to adjust several items concurrently.

### 12 INFO

Displays the "Source Information" or "Projector Information" window. This button toggles between these two windows.

### 13 TEST

Press to display the test pattern. Pressing this button sequentially selects five test patterns.

### 14 HELP

Provides online help.

### 15 PIXEL

Displays the Pixel Adjust screen to adjust the clock and phase.

### 16 AUTO (RGB only)

Press to adjust Position-H/V and Pixel Clock for an optimal picture.

**NOTE:** The Pixel Phase is not available.

### 17 POSITION

Press to display the Blanking screen; press again to display the Position screen.

While pressing and holding CTL, pressing this button displays the Lens Shift adjustment screen.

### 18 MUTE SOUND

(available only when using with the ISS -6020 or IPS4000)

Turns off the sound for a short period of time. Press again to restore the sound.

### 19 MUTE OSD

Press to turn off the on-screen display. Press again to restore the on-screen display.

**NOTE:** You can also turn off the on-screen display by pressing and holding CTL and then pressing MUTE OSD; doing this again restores it. In this case any adjustment will still change the projector's memory settings. This mode is available even when an input is switched to another or the power is turned off using the POWER OFF button on the remote control.

### 20 MUTE PICTURE

Press to turn off the picture for a short period of time. Press again to restore the picture. Pressing and holding CTL, then pressing this button shuts off the light completely.

**NOTE:** This is also considered the LENS SHUTTER.

### 21 KEYSTONE (R)

Press to display the Keystone Correction screen.

### 22 AMPLITUDE (G)

Service personnel only.

### 23 ENTRY LIST (B)

Press to display the Entry List screen.

### 24 FOCUS (+/-)

While pressing and holding CTL, pressing this button allows you to adjust the lens focus.

### 25 MAGNIFY/ZOOM (+/-)

Magnify the size of a target portion.

While pressing and holding CTL, pressing this button allows you to zoom the lens in and out.

### 26 CTL

Used in conjunction with other buttons, similar to a shift key on a computer.

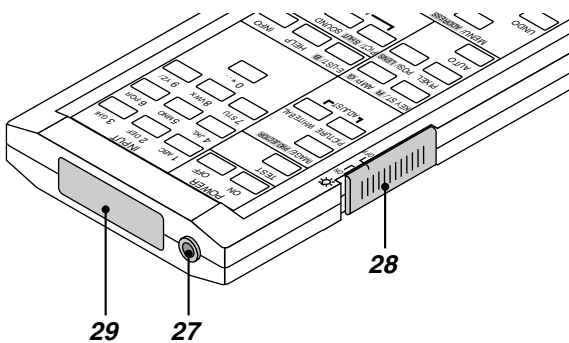

### 27 Remote Jack

Connect your remote control cable here for wired operation.

### 28 Backlight Switch

**When using the remote control wirelessly:**

Turns the backlight on and off. If no button operation is made within 30 seconds with the Backlight ON, the Backlight will turn off to conserve battery life.

**When using as the wired remote control:**

The light stays on in standby and power-on.

### 29 Infrared Transmitter

Direct the remote control toward the remote sensor on the projector cabinet.

## Remote Control Precautions

- Use the remote control within a distance of about 7m (23feet) and at an angle of 30° above, below, to the left and to the right of the remote control sensor located at the front of the main unit.
- The remote control system may not function when direct sunlight or strong illumination strikes the remote control sensor of the main unit, or when there is an obstacle in the path.
- When remote control buttons are pressed and held, main unit function keys may not operate.
- Do not subject to strong shock.
- Do not allow water or other liquid to splash on the remote control. If the remote control gets wet, wipe it dry immediately.
- Avoid exposure to heat and steam.
- Remove the batteries from the remote control when the remote control is not going to be used for a long period.

You cannot operate the projector using the remote control if:

- the remote ID is not set to [00].
- the remote ID is not the same as the projector ID.  
See page E-23 for setting remote ID and page E-39 for setting projector ID.

## Remote Control Battery Installation

Installing the Remote Control Batteries

When it comes time to replace the batteries, two "AA" type will be required.

1. Press and open the cover.

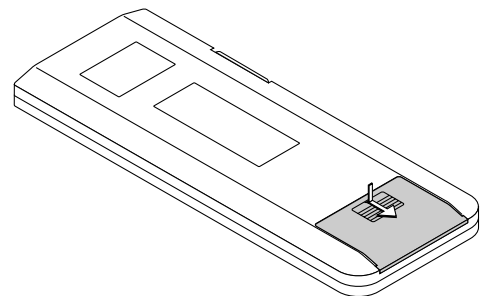

2. Align and insert the batteries according to the (+) and (-) indications inside the case.

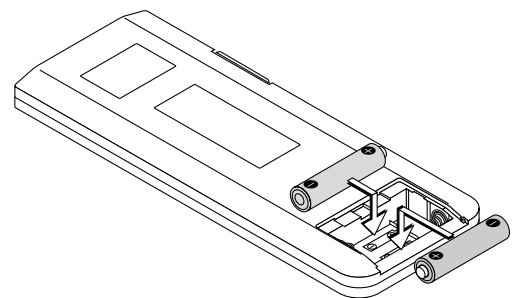

3. Replace the cover.

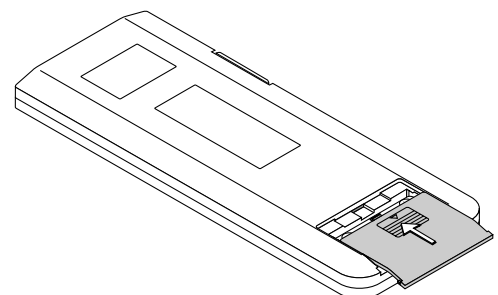

# 2. INSTALLATION

This section describes how to set up your projector and how to connect video and audio sources.

## Screen Size and Projection Distance

Applicable lens and throw distance/ List of screen sizes

### Setting Up Your Projector

Your Projector is simple to set up and use. But before you get started, you must first:

1. Determine the image size
2. Set up a screen or select a non-glossy white wall onto which you can project your image.
3. Install the optional lens to the projector.
 

**NOTE:** The lens must be installed by service personnel only.
4. Connect the supplied power cable.
5. Set up the projector.
6. Connect a PC, VCR, DVD player, or other equipment.
7. Make settings or adjustments on the projector.

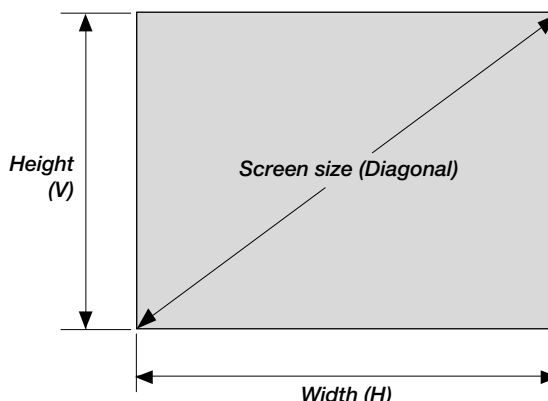

Formulas: Screen Width H (5:4) (m) = Screen Height V x 5/4 x 0.0254  
 Screen Height V (5:4) (m) = Screen Width H x 4/5 x 0.0254  
 Screen Diagonal (5:4) (m) = Screen Height V x 6.4/4 x 0.0254  
 Screen Width H (5:4) (inch) = Screen Height V x 5/4  
 Screen Height V (5:4) (inch) = Screen Width H x 4/5  
 Screen Diagonal (5:4) (inch) = Screen Height V x 6.4/4

### Throw Distance

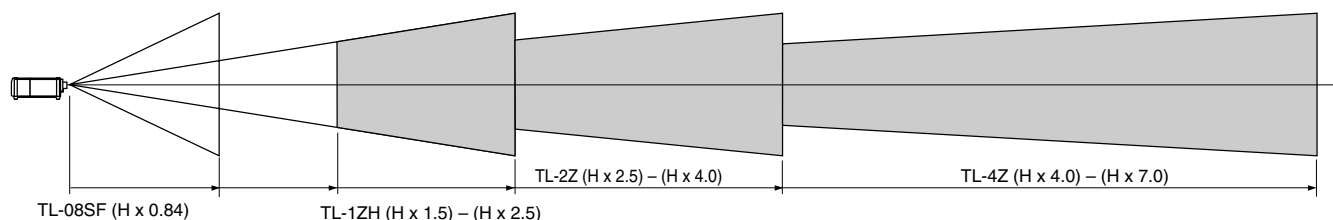

**NOTE:** Image has 5:4 aspect ratio. Take this into account when specifying a screen.

### Table of Throw Distances and Image Sizes for Optional Lenses

Unit: m (inch)

Screen Size (5:4)		SF Fixed Lens	Zoom Lens		
Width (H)	Height (V)	TL-08SF	TL-1ZH	TL-2Z	TL-4Z
		0.84:1	1.5-2.5	2.5 - 4.0	4.0-7.0
1.6(63)	1.2(50.4)	1.3(52.9)	2.4(94.5) - 4.0(157.5)	4.0(157.5) - 6.4(252)	6.4(252) - 11.2(441)
1.9(75)	1.5(60)	1.6(63)	2.9(112.5) - 4.8(187.5)	4.8(187.5) - 7.6(300)	7.6(300) - 13.3(525)
2.3(90)	1.8(72)	1.9(75.6)	3.4(135) - 5.7(225)	5.7(225) - 9.1(360)	9.1(360) - 16.0(630)
2.9(112.5)	2.3(90)	2.4(94.5)	4.3(168.8) - 7.1(281.3)	7.1(281.3) - 11.4(450)	11.4(450) - 20.0(787.5)
3.4(135)	2.7(108)	2.9(113.4)	5.1(202.5) - 8.6(337.5)	8.6(337.5) - 13.7(540)	13.7(540) - 24.0(945)
4.0(157.5)	3.2(126)	3.4(132.3)	6.0(236.3) - 10.0(393.8)	10.0(393.8) - 16.0(630)	16.0(630) - 28.0(1102.5)
4.6(180)	3.7(144)	3.8(151.2)	6.9(270) - 11.4(450)	11.4(450) - 18.3(720)	18.3(720) - 32.0(1260)
5.1(202.5)	4.1(162)	4.3(170.1)	7.7(303.8) - 12.9(506.3)	12.9(506.3) - 20.6(810)	20.6(810) - 36.0(1417.5)
5.7(225)	4.6(180)	4.8(189)	8.6(337.5) - 14.3(562.5)	14.3(562.5) - 22.9(900)	22.9(900) - 40.0(1575)
6.7(262.5)	5.3(210)	5.6(220.5)	10.0(393.8) - 16.7(656.3)	16.7(656.3) - 26.7(1050)	26.7(1050) - 46.7(1837.5)
7.6(300)	6.1(240)	6.4(252)	11.4(450) - 19.1(750)	19.1(750) - 30.5(1200)	30.5(1200) - 53.3(2100)
8.6(337.5)	6.9(270)	7.2(283.5)	12.9(506.3) - 21.4(843.8)	21.4(843.8) - 34.3(1350)	34.3(1350) - 60.0(2362.5)
9.5(375)	7.6(300)	8.0(315)	14.3(562.5) - 23.8(937.5)	23.8(937.5) - 38.1(1500)	38.1(1500) - 66.7(2625)

For screen sizes between 80" and 500" not indicated on the above table, use formulas below.

Projection Distance = Screen Width (H) x Lens Magnification

Throw distance for TL-08SF lens = H x 0.84

Throw distance for TL- 1ZH lens = H x 1.5 - H x 2.5

Throw distance for TL- 2Z lens = H x 2.5 - H x 4.0

Throw distance for TL- 4Z lens = H x 4.0 - H x 7.0

**NOTE:** Distances may vary +/- 5%.

## Lens Shift Adjustable Range

Lens Shift Adjustable Range for Desktop and Ceiling Mount Application

The diagram below shows the location of the image position in the lens. The lens can be shifted within the shaded area as shown using the normal projection position as a starting point.

### Maximum Possible Range for TL-12H, TL-2Z and TL-4Z

Parenthesized values for the ceiling mount application

Up: 0.41 V (0.24 V) Right: 0.28 H (0.19 H)

Down: 0.24 V (0.41 V) Left: 0.19 H (0.28 H)

(H: width of projected image, V: height of projected image)

#### Desktop/ Front Vertical

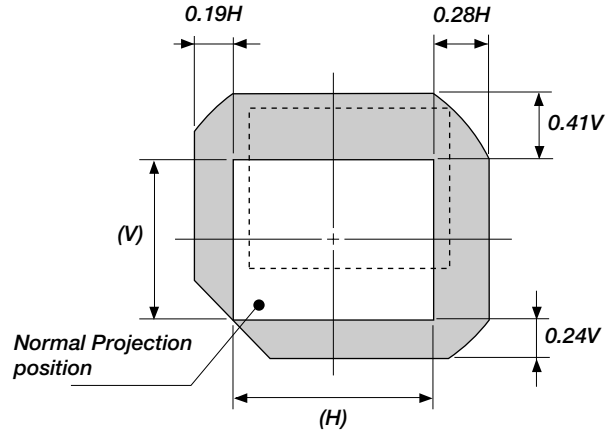
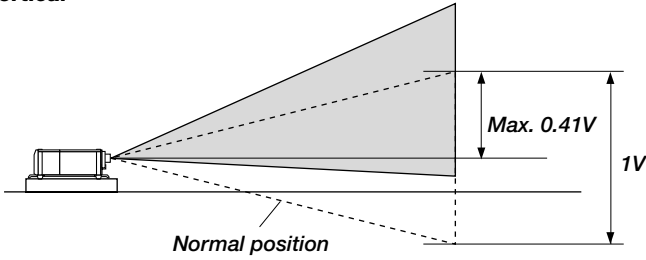

#### Ceiling/ Front Vertical

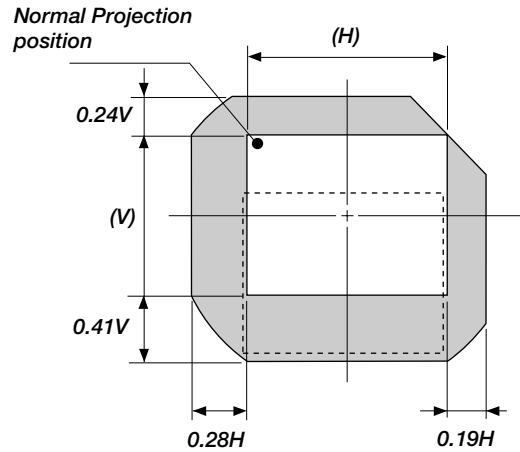
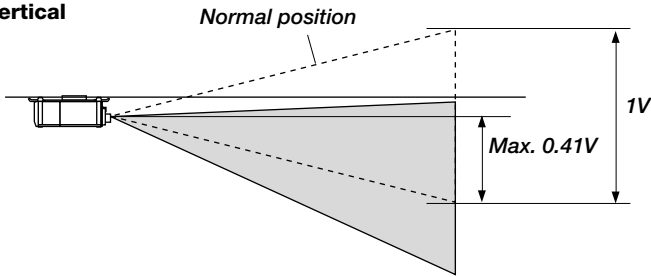

#### Example for Stack

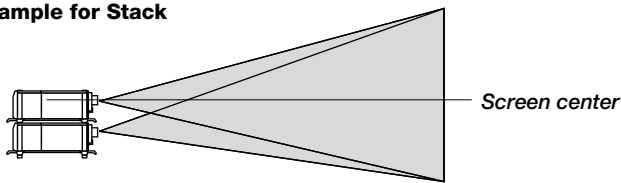

### Fixed Lens TL-08SF

Maximum Possible Range for TL-08SF

Up: 0.09 V Right: 0.06 H

Down: 0.09 V Left: 0.06 H

(H: width of projected image, V: height of projected image)

**NOTE:** To reduce the distortion of an image, it is recommended that the projector is horizontally positioned at a projection angle of 0 degree.

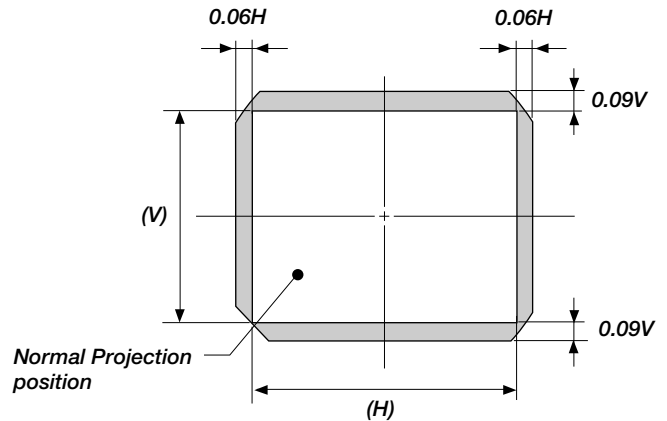
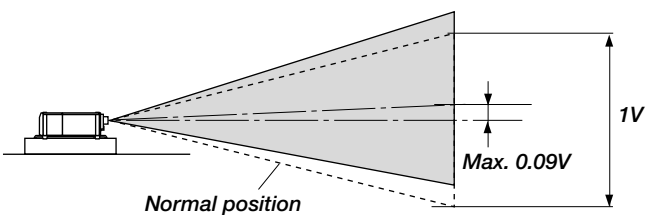



## Moving The Projector

Always carry your projector by the handle. Ensure that the power cable and any other cables connecting to video sources are disconnected and the lens is removed from the projector before moving the projector. When moving the projector or when it is not in use, cover the lens with the lens cap.

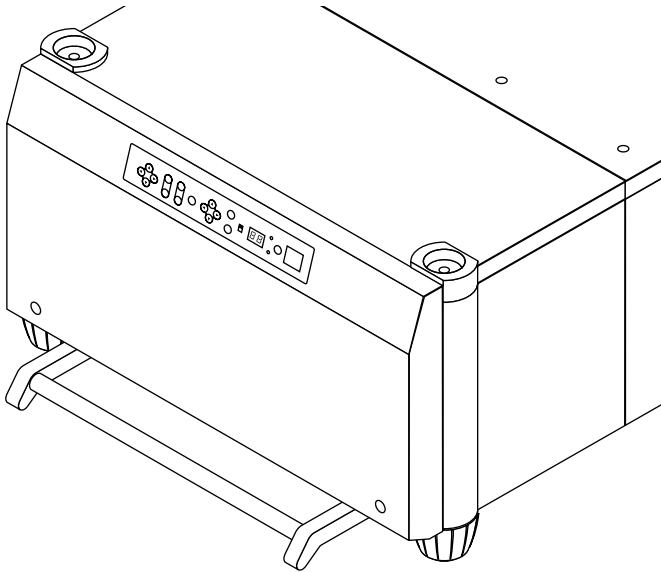
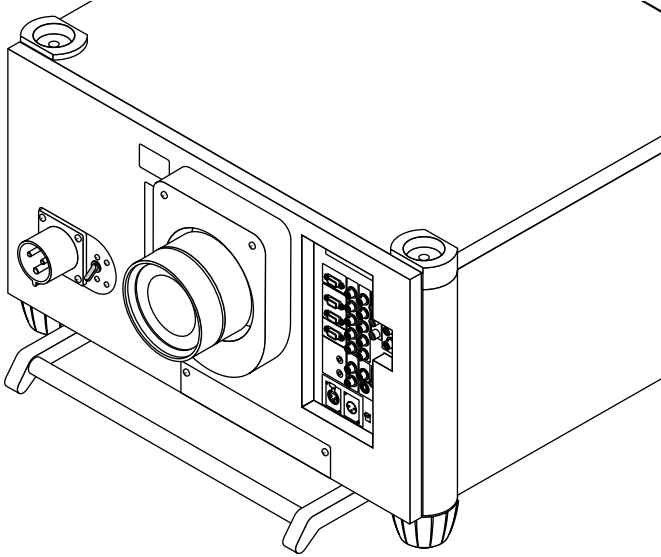

## Selecting A Location

The further your projector is from the screen or wall, the larger the image. The minimum size the image can be projected is 80" (2 m) measured diagonally. The largest the image can be is 500" (12.7 m).

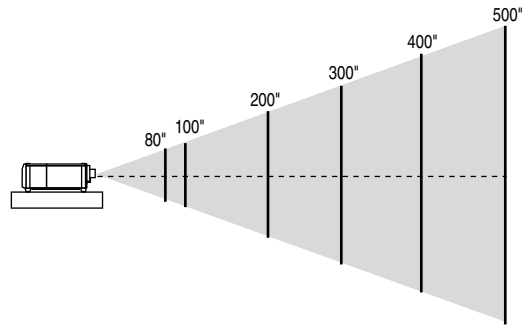

## WARNING

- Only use your projector on a solid, level surface. If the projector falls to the ground, you can be injured and the projector severely damaged.
- Do not use the projector where temperatures vary greatly. The projector must be used at temperatures between 40 degrees F (5 degree C) and 95 degrees F (35 degree C).
- Do not expose the projector to moisture, dust, or smoke. This will degrade the screen image.
- Ensure that you have adequate ventilation around your projector for proper heat dissipation. Do not cover the vents on the projector cabinet.

# 3. SETUP

## Connecting the Power Cable and Turning on the Projector

Before you turn on your projector, ensure that the computer or video source is turned on and that your lens cap is removed.

1. **Connect the supplied power cable to the projector.**  
Plug the supplied power cable into the AC outlet.

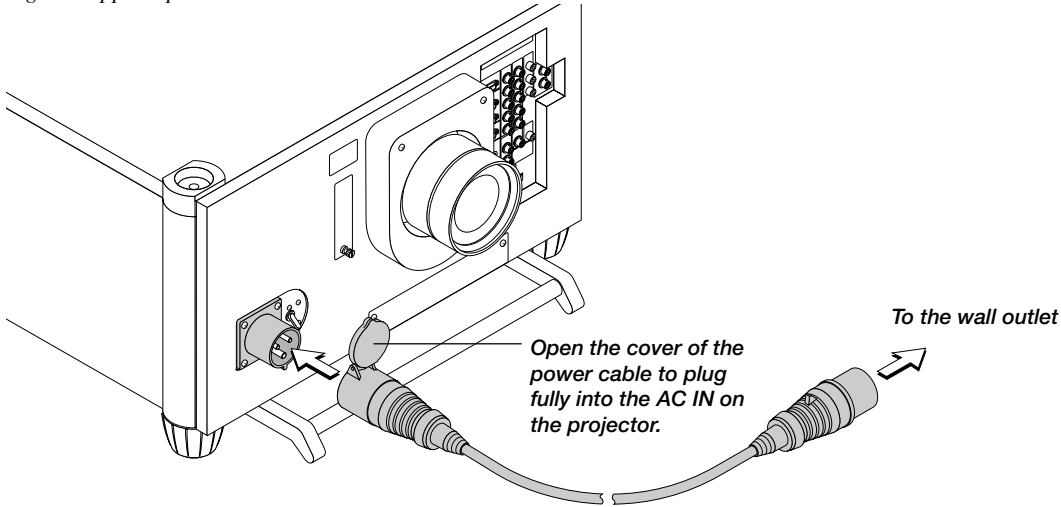

2. **Turn On The Projector**

The main power switch is on the front panel of the projector. By pushing up this switch, the projector will go into its standby mode and the POWER indicator will glow orange. Only after you press the 'POWER ON' button on the remote control or projector cabinet will the POWER indicator turn to green and the projector will fully turn on.

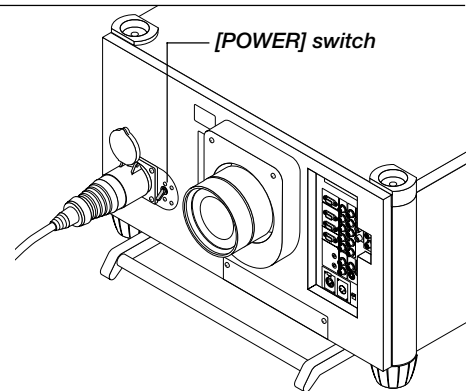
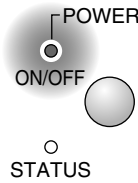
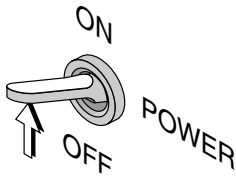

3. **Turn Off The Projector**

First press the POWER OFF button on the remote control or the projector cabinet for a minimum of two seconds. Allow the fan to cool the projector for three minutes. This will extend the life of the lamp. After the cooling fan stops working, the POWER indicator will change to a steady orange glow and the projector will be in the stand-by mode. Then turn off the main power switch on the front panel. The POWER indicator will go out. If you desire to move the projector then unplug the power cable.

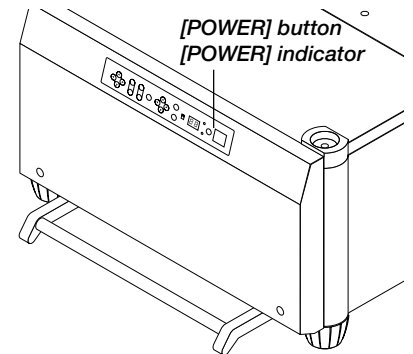
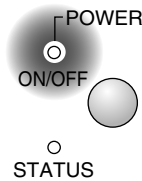
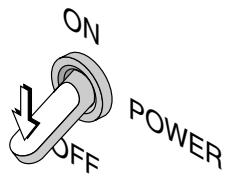

**NOTE:** Immediately after turning on the projector, screen flicker may occur. This is not a fault. Wait 3 to 5 minutes until the lamp lighting is stabilized.

**CAUTION:** Do not turn off the main power while the cooling fan is working.

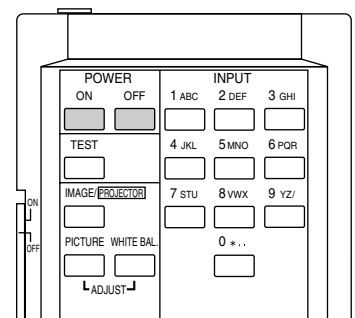

## About Startup Screen

### (Menu Language Select screen)

When you first turn on the projector, you will get the Startup screen.

This screen gives you the opportunity to select one of the seven menu languages: English, German, French, Italian, Spanish, Swedish and Japanese.

To select a menu language, follow these steps:

1. Use the Select ▲ or ▼ button to select one of the seven languages for the menu.



2. Press the Enter button to execute the selection.

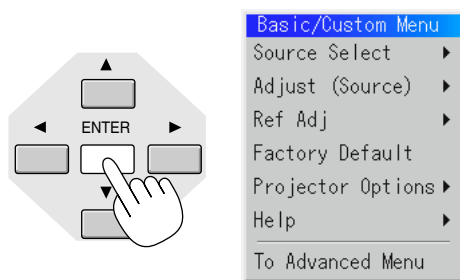

3. The Basic/Custom menu will be displayed in the language you have selected.

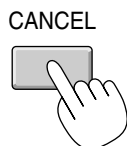

To close the menu, press the Cancel button.

After this has been done, you can proceed to the advanced menu operation.

If you want, you can select the menu language later. See "Language" on page E-37.

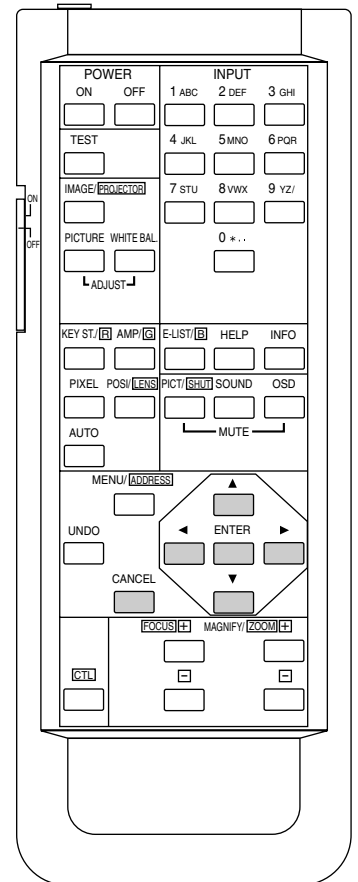

## Set up the projector

1. Turn on the projector
2. Select your type of projection:  
Desktop front, ceiling rear, desktop rear, and ceiling front.

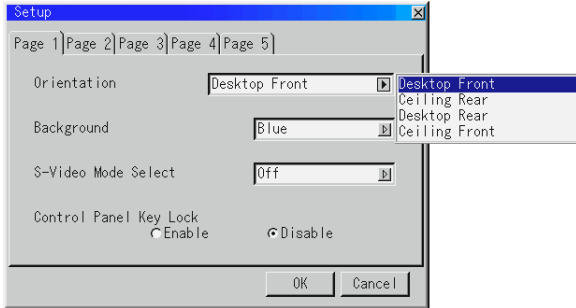

3. Display the test pattern by pressing the TEST button on the remote control or using the menu.

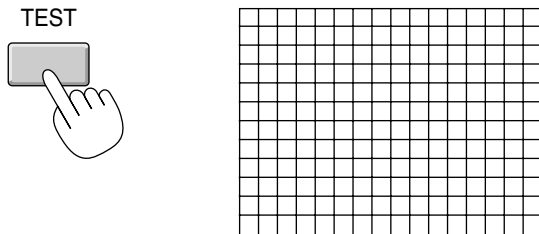

4. Adjust the image position and the image size.

- (1) Press and hold the CTL button and press the POSITION button to display the Lens Shift adjustment screen.  
Use the Select button on the remote control or the LENS SHIFT button on the projector cabinet to move the image horizontally and vertically.  
To close the Lens Shift adjustment screen, press the CANCEL button.  
See page E-9 for "Lens Shift Adjustable Range".

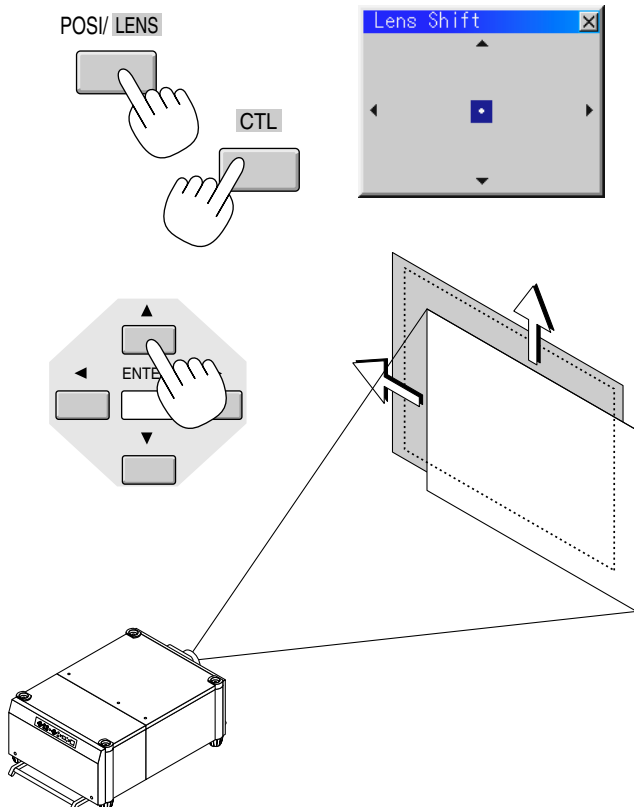

- (2) Press and hold the CTL and press the ZOOM + or - button to adjust the image size optically. You can also adjust the image size by using the ZOOM + or - button on the projector cabinet.

The zoom function processes a signal digitally. For this reason, the zoom buttons on the remote control and the projector cabinet are not available for HDTV, Video, S-Video, and SDI signals.

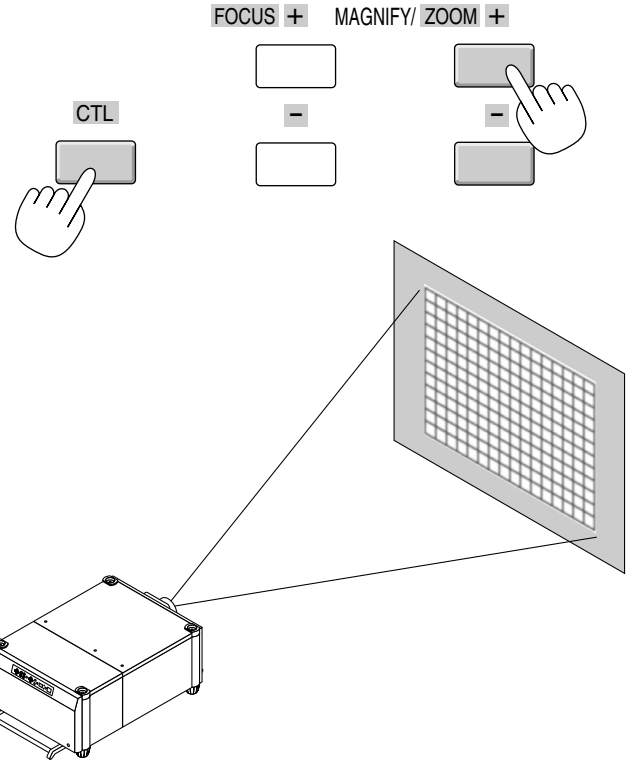

- (3) Press and hold the CTL button and press the FOCUS + or - button to obtain the best focus optically. You can also adjust the focus by using the FOCUS + or - button on the projector cabinet.

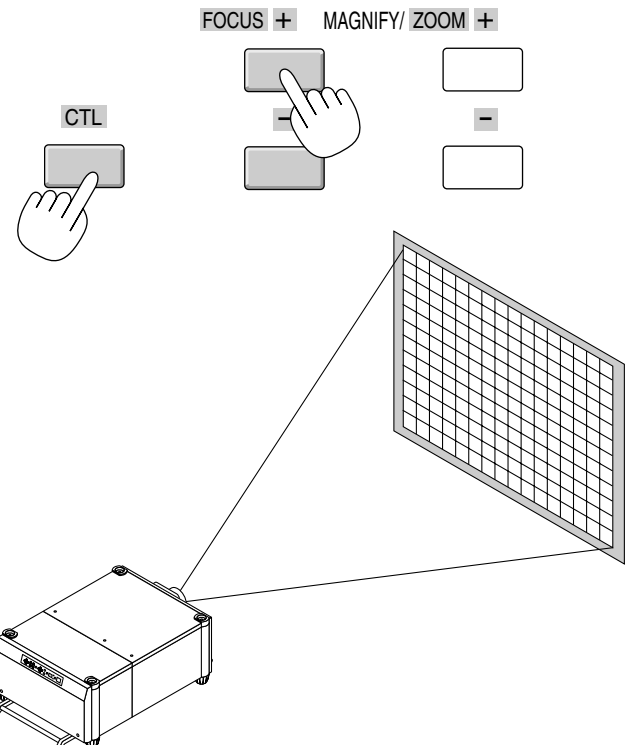

## Keystone

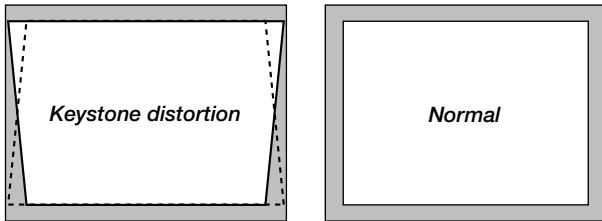

Keystone is the distortion of a projected image that usually creates a wider top than bottom. Aiming a projector upward on a wall rather than straight at a wall creates this distortion. Use the ◀ or ▶ buttons on the slide bar to correct this keystone (trapezoidal) distortion.

**NOTE:** The keystone feature is not available when the test pattern or the blue background is displayed.

**NOTE:** With the projector aimed directly at the screen the maximum keystone angle that can be corrected is +/- 7.5 degrees.

## Setting up for Double Stacking in Link Mode

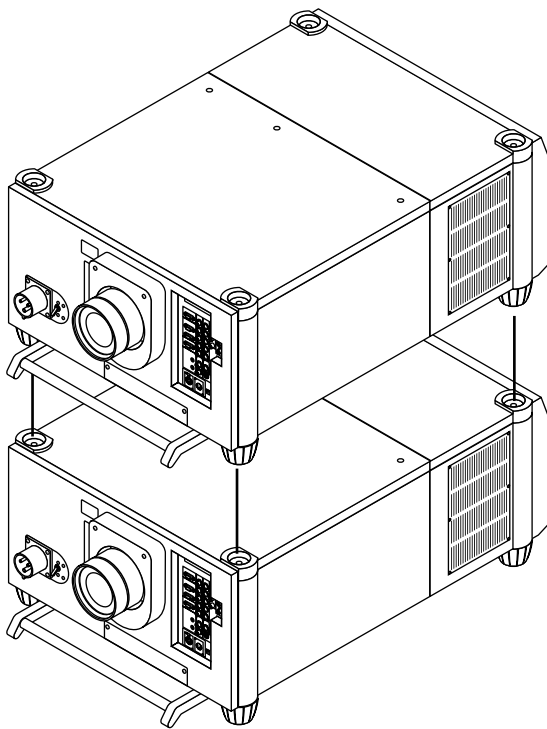

**CAUTION:** To prevent the projectors from falling, install them in a place and fasten them in a way with sufficient strength to support the two projectors.

**NOTE:** SW 1 Level and SW 2 Level of Switcher Control are not available in Link Mode.

### 1) Stacking the Projectors

1-1. Place the projectors at the proper height for best screen to projector relationship. Make sure that all projectors have the same display orientation.

### 2) Hookup

2-1. Use the supplied DVI-D cable to connect the RGB DIGITAL output of the master projector to the RGB DIGITAL input (INPUT9 ) of the slave projector until all the projectors are connected.

2-2. Next, using a commercially available, bi-directional RS-232C cable connect the OPTION OUT terminal of the master projector to the OPTION IN terminal of the slave projector until all the projectors are connected.

2-3. Turn all the projectors on and roughly make some optical adjustments to each projector.

### 3) Adjusting and registering signals to be projected in Link mode and stack application.

Signal Data Preparation

3-1. Create data for the master projector and copy data to the slave projector.

3-1-1. Choose one projector as the master.

3-1-2. Turn the master projector on.

3-1-3. Display all desired input signals, make adjustment to each signal, then save all adjustments on the master projector. (Adjustments will be saved automatically.)

3-1-4. Turn the master projector off (standby mode).

3-1-5. Store all the adjustments on a PC card from the master projector.

3-1-5-1. Open the PC Card slot cover to access the PC card slot. Insert a PC card into this slot.

**NOTE:** DO NOT TURN OFF THE POWER while the PC Card Access indicator is flashing. Doing so will cause damage to the data of the projector system.

**NOTE:** Back up your data if you use the supplied CompactFlash card to copy the data from the master projector to the slave projector. The supplied CompactFlash card contains data and firmware for factory use.

3-1-5-2. Press and hold CANCEL, then press POWER on the rear panel of the master projector. The POWER indicator will change to steady green and the PC Card Access indicator will start flashing. After storing data on the PC card, the POWER indicator will change to orange.

3-1-5-3. Remove the PC card from the slot of the master projector.

3-1-6. Transfer the data to the slave projector using the PC card so that all the projectors have the same data in memory.

3-1-6-1. Insert the PC card into the slot of a slave projector.

**NOTE:** Since data in the slave projector will be lost at this time, make backup copies of them before proceeding.

3-1-6-2. Press and hold ENTER, then press MENU on the rear panel of the slave projector. The POWER indicator will change to steady green and the PC Card Access indicator will start flashing to indicate that the data is being copied from the PC card to the slave projector. After copying data to the slave projector, the POWER indicator will change to orange.

---

3-1-6-3. Remove the PC card from the slave projector.

**NOTE:** If you select the RGB1 input on the master projector, you must select the same input on the slave projector. The same applies to the RGB2 input.

**NOTE:** After adjusting and registering signals as mentioned above, you must change the input to RGB on the Entry Edit Command window for Link Mode. See "Entry List Edit" on page E-31 for changing to RGB source.

3-1-6-4. Display the desired source.

#### 4) Display the internal crosshatch test pattern.

**NOTE:** Use a different single color for each projector.

Example:

Turn on Green of one projector (master), then Red of the other (slave).

#### 5) Adjusting the lens shift, zoom and focus to clearly display all projected patterns.

5-1. Adjust the Lens Shift using the LENS SHIFT button on the projector cabinet. You can also adjust the Lens Shift by pressing and holding CTL and pressing the POSITION button on the remote control. For Lens Shift Adjustable Range, see page E-9.

5-2. Zoom the lens in and out by using the ZOOM button on the projector cabinet or the remote control.

5-3. Adjust the lens focus by using the FOCUS button on the projector cabinet or the remote control.

**NOTE:** If the physical (vertical) alignment of the projector is not correct, adjust the height of the feet. If there is any keystone distortion, use Keystone adjustment to correct and save the settings on each projector. See page E-14 and E-35 for Keystone correction. See page E-39 for Keystone save. This completes set-up and adjustments. An image is projected from the master projector. See page E-39 for Link mode.

#### 6) Link Mode Setting

6-1 Assign a unique Projector ID for each projector.

6-1-1. Select [Projector Options] →[Setup] →[Page 5] →[Projector ID]. See page E-39 for specifying ID.

6-1-2. Specify a unique projector ID for each projector.

6-2 Select the same communication speed for all the projectors.

6-2-1. Select [Projector Options] →[Setup] →[Page 5] →[Communication Speed]. See page E-39 for setting the communication speed.

6-2-2. Select the appropriate speed between 4800 and 38400.

6-3 Set the Link Mode on each projector.

6-3-1. Select [Projector Options] →[Link Mode].

6-3-2. First select [Slave] on the slave projector.

6-3-3. Select [Master] on the master projector. See page E-39 for setting Link Mode.

6-4 Project a source image from all projectors

6-4-1. Display any signal onto the screen.

6-4-2. Check to see if the images on the master projector are displayed in synchronization with the ones on the other slave projector while the projectors are in link mode.

**NOTE:** Registering signals is not possible in the Link mode. To register a signal, first set "Link Mode" to "Standalone" on the menu and then repeat the above steps from 3. If you select an unregistered signal, the master projector displays the image, but the slave projector doesn't. To view the information on the currently displayed signal, select [Help] → [Source Information].

6-5 Make adjustments to the slave projector.

**NOTE:** See "List of Menu Items Available on Link Mode" on page E-45 for more information.

6-5-1. Temporarily, change the master projector from Master to Standalone. Make sure that the slave projector is still in Slave mode.

6-5-2. Display a source you want to adjust from the master projector.

6-5-3. On the Slave Projector select the same signal From the Entry List (same No.) as that of the master projector. Display it from the slave projector.

6-5-4. Make Picture adjustment such as brightness, contrast, or color temperature.

6-5-5. Change the master projector from Standalone to Master to activate the Link Mode

6-6 This completes the Link Mode adjustment procedure.

**NOTE:** When the Link mode is enabled, be sure to turn on the master projector first and then the slave projector. If you fail to do this, the slave projector will not work correctly. Once you have turned on the master projector, the slave projector will automatically be turned on.

**NOTE:** In the Link mode the Lens Memory feature is not available.

## Projector Orientation

An image can be projected from in front or behind a screen, and the projector can be installed on the ceiling\*.

### Ceiling Front Projection

Use [Projector Options] → [Setup] → [Page 1] → [Orientation] to select "Ceiling Front". (See page E-38.)

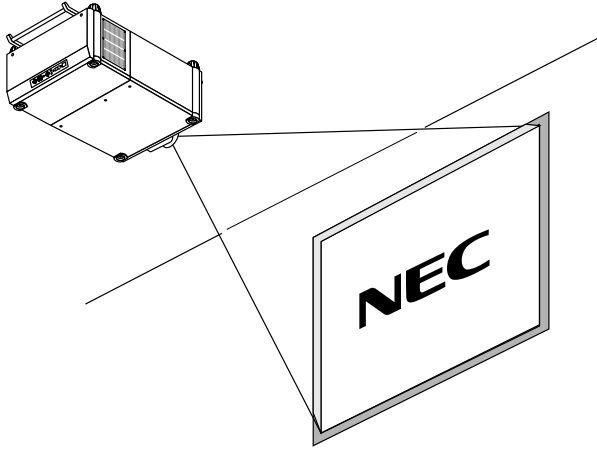

### Ceiling Rear Projection

Use [Projector Options] → [Setup] → [Page 1] → [Orientation] to select "Ceiling Rear". (See page E-38.)

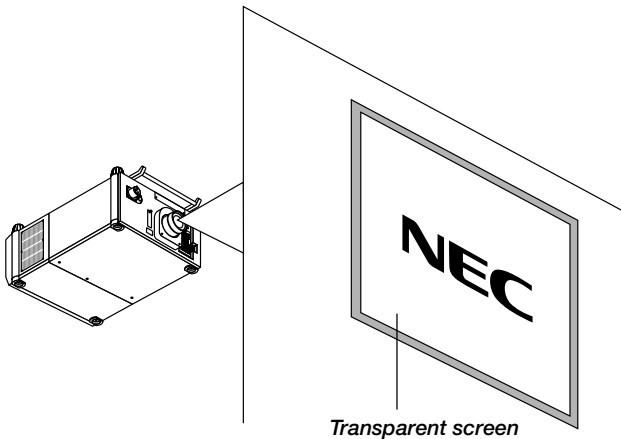

### Desktop Rear Projection

Use [Projector Options] → [Setup] → [Page 1] → [Orientation] to select "Desktop Rear". (See page E-38.)

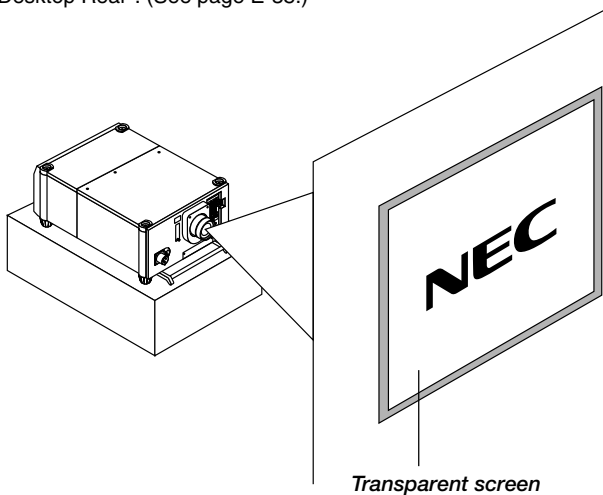

## WARNING

- Installing your projector on the ceiling must be done by a qualified technician. Contact your NEC dealer for more information.
- \* Do not attempt to install the projector yourself.
- Only use your projector on a solid, level surface. If the projector falls to the ground, you can be injured and the projector severely damaged.
- Do not use the projector where temperatures vary greatly. The projector must be used at temperatures between 40°F (5°C) and 95°F (35°C).
- Do not expose the projector to moisture, dust, or smoke. This will harm the screen image.
- Ensure that you have adequate ventilation around your projector so heat can dissipate. Do not cover the vents on the projector.

# 4. CONNECTIONS

## When used in standalone operation

### Connecting Your PC Or Macintosh Computer

Connecting your PC or Macintosh computer to SX10000 Projector will enable you to project your computer's screen image for an impressive presentation.

To connect to a PC or Macintosh :

1. Turn off the power to your projector and computer.
2. Use a signal cable (not provided) to connect your PC or Macintosh computer to the projector.
3. Turn on the projector and the computer.
4. If the projector goes blank after a period of inactivity, it may be caused by a screen saver installed on the computer.

### Connecting Your Document Camera

You can connect the projector to a document camera. To do so, simply:

1. Turn off the power to your projector and document camera.
2. Use the supplied RGB signal cable to connect your document camera to the Video input on your projector. Or connect to the INPUT3 (RGB) on your projector.
3. Turn on the projector and the document camera.

**NOTE:** Refer to your document camera's owner's manual for more information about your camera's video output requirements .

### Connecting Your VCR Or Laser Disc Player

Use common RCA cables (not provided) to connect your VCR or laser disc player to your SX10000 Projector. To make these connections, simply:

1. Turn off the power to your projector and VCR or laser disc player.
2. Connect one end of your RCA cable to the video output connector on the back of your VCR or laser disc player, connect the other end to the Video input on your projector. Use standard RCA audio patch cords to connect the audio from your VCR or laser disc player to your sound system (if your VCR or laser disc player has this capability). Be careful to keep your right and left channel connections correct for stereo sound.
3. Turn on the projector and the VCR or laser disc player.

**NOTE:** Refer to your VCR or laser disc player owner's manual for more information about your equipment's video output requirements.

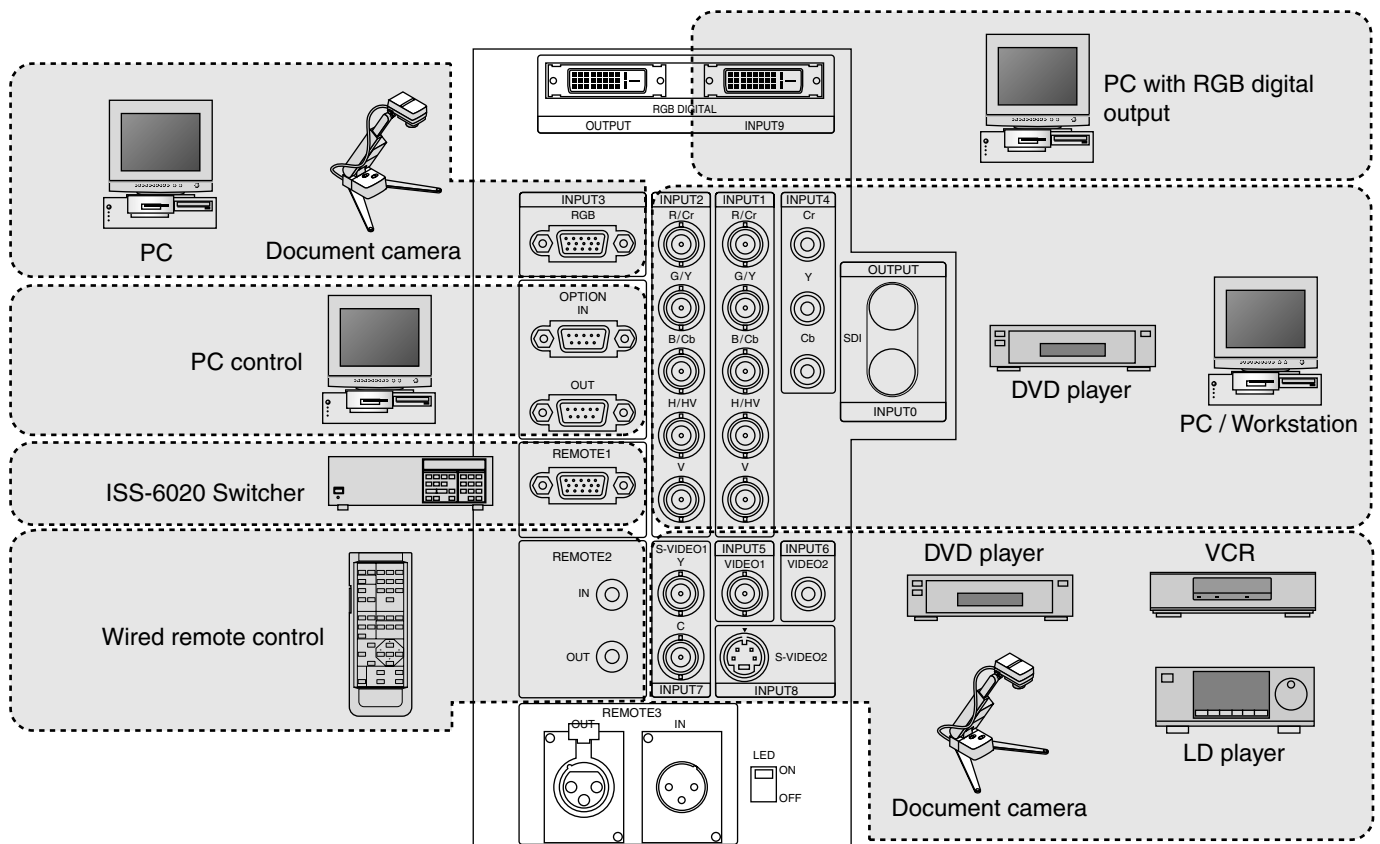



## When Used with One Switcher (ISS-6020/ISS-6020G)

Up to 10 input signals can be accepted when the projector is connected to one Switcher. Using the projector with the Switcher allows easy adjustment and signal selection.

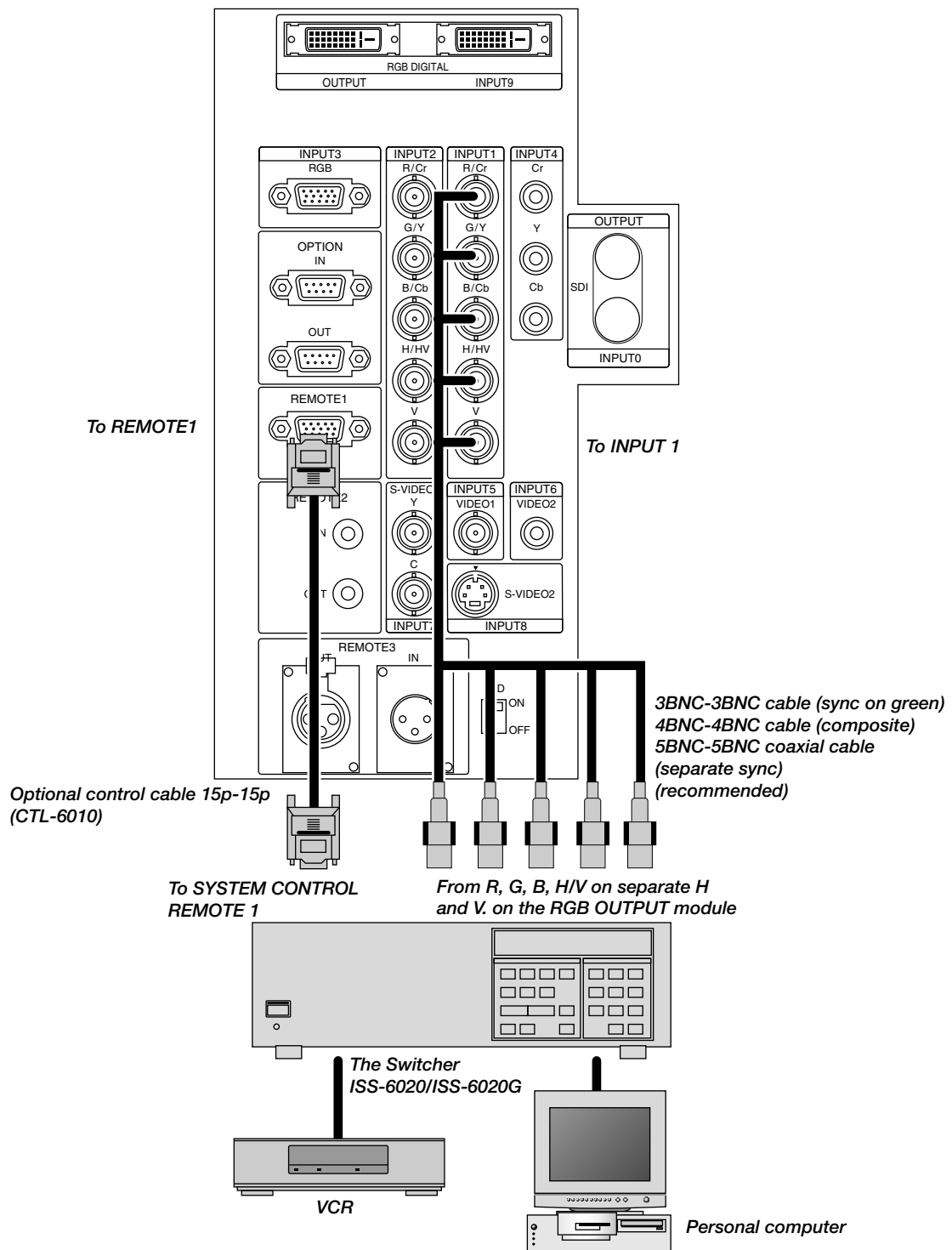

- Select [Menu] → [Projector Options] → [Switcher Control] → [SW1 Level]. See page E-39 for the information in detail.
- For more information on the Switcher, refer to the user's manual accompanying the ISS-6020/ISS-6020G Switcher.
- All cables mentioned above are sold separately.
- The RGB2 terminal will not work with the Switcher Control function.
- \* When connecting with the VIDEO INPUT MODULE (6020-VID), set the VIDEO MODE select switch (S3001) to "8". The VIDEO MODE select switch is located on the VIDEO INPUT MODULE (6020-VID).

**NOTE:** While in the Switcher Control mode, a video standard is selected at the projector. If you set the VIDEO MODE select switch (S3001) to "8" with the QUAD DECODER installed in the Switcher ISS-6020, the image will not be displayed correctly. In that case, first remove the QUAD DECODER from the Switcher ISS-6020. For more details, contact your dealer.

## When Used with Two or More Switchers (100 Inputs)

Up to 100 inputs can be accepted using the NEC ISS-6020 Switcher.

### How to make connections:

1. Connect the REMOTE 1 terminal of the master Switcher to the REMOTE 1 of the projector using the optional control cable (15p-15p/CTL-6010).
2. Next connect the REMOTE 2 terminal of the master Switcher to the REMOTE 1 terminal of the first slave Switcher using the same optional control cable as mentioned above. Third, connect the REMOTE 2 terminal of the first slave to the REMOTE 1 of the second slave, and the REMOTE 2 terminal of the second slave to the REMOTE 1 terminal of the third slave (— and the REMOTE 2 of the ninth slave to the REMOTE 1 of the tenth slave). Connect all the Switchers with optional control cables.

### NOTE:

- Be sure to set all the slide switches (S8603) of the Switcher to RS-422 positions. Set the one on the last slave Switcher to the appropriate position to match the connected equipment such as a personal computer. (RS-422/RS-232C for PC control of projector)
- Set the DIP switch S8601 of the Switcher.

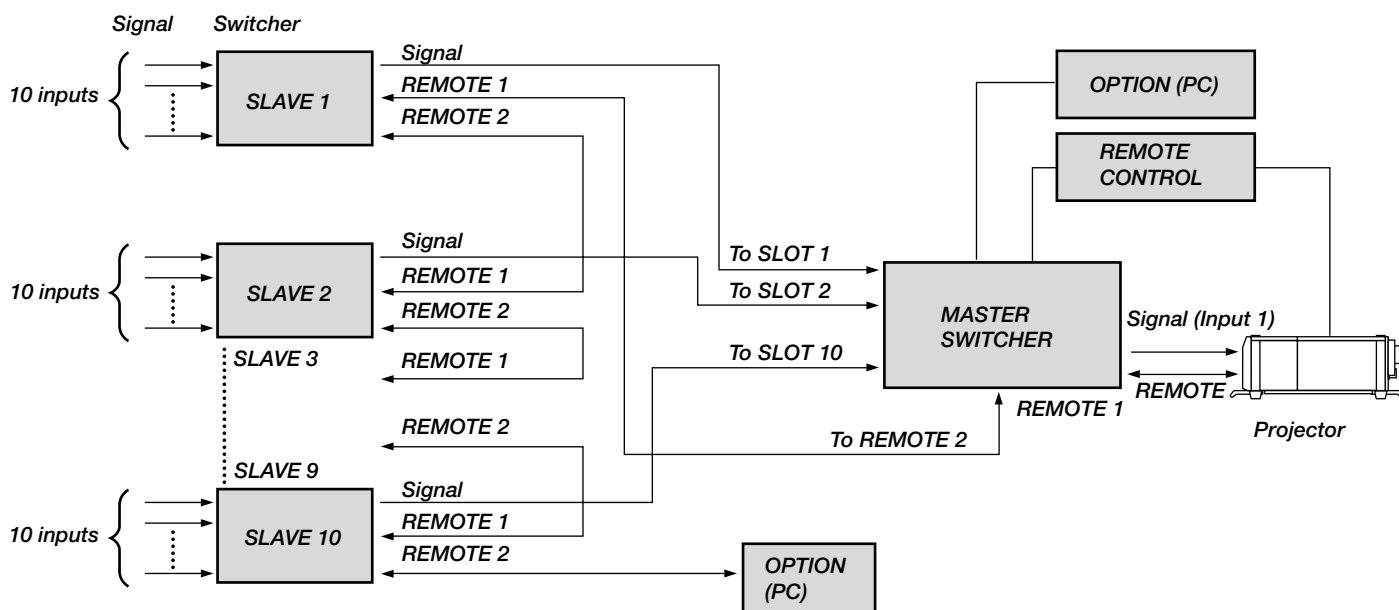

**NOTE:** The optional remote control RC-6320 for ISS-6020 will not work correctly in the SW Level 1 or 2 mode.

To use the projector with the Switcher ISS-6020 in the Switcher Control mode,

- \* When connecting with the VIDEO INPUT MODULE (6020-VID), set the VIDEO MODE select switch (S3001) to "8". The VIDEO MODE select switch is located on the VIDEO INPUT MODULE (6020-VID).

**NOTE:** While in the Switcher Control mode, a video standard is selected at the projector.

If you set the VIDEO MODE select switch (S3001) to "8" with the QUAD DECODER installed in the Switcher ISS-6020, the image will not be displayed correctly.

In that case, first remove the QUAD DECODER from the Switcher ISS-6020.

For more details, contact your dealer.

**Set the DIP switch (S8601) of the Switcher as follows:**

*NOTE: Slave numbers 1 to 10 must correspond to the master's slot numbers 1 to 10.*

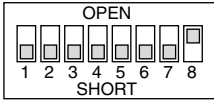
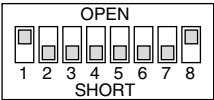
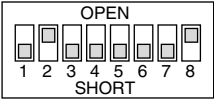
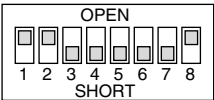
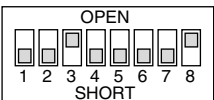
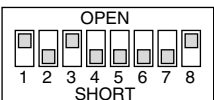
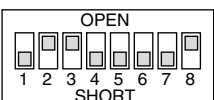
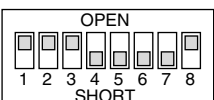
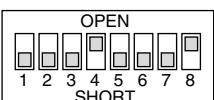
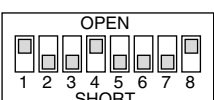
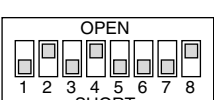
ISS-6020 ISS-6020G	Output to	Setting of S8601
<b>Master</b>	The Projector	
<b>Slave 1</b>	Slot 1 of the Master	
<b>Slave 2</b>	Slot 2 of the Master	
<b>Slave 3</b>	Slot 3 of the Master	
<b>Slave 4</b>	Slot 4 of the Master	
<b>Slave 5</b>	Slot 5 of the Master	
<b>Slave 6</b>	Slot 6 of the Master	
<b>Slave 7</b>	Slot 7 of the Master	
<b>Slave 8</b>	Slot 8 of the Master	
<b>Slave 9</b>	Slot 9 of the Master	
<b>Slave 10</b>	Slot 10 of the Master	

## REMOTE 1 Connector

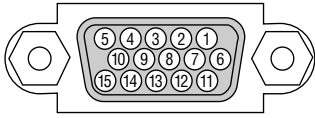

This connector is used for either connecting the ISS-6020/ISS-6020G Switcher or a third party external control device (Contact Closure). When the Switcher is used, connect it with the optional control cable (15-15 pin; 50 ft./16m; CTL-6010) to this connector.

### When used with the Switcher.

Pin No.	FUNCTION
1, 2, 6 and 7	Sending and receiving data when the Switcher is used.
9	Identifying the Projector
15	Ground
3, 8, 11 and 12	Used inside the Projector. Normally set to OPEN.

When using with the Switcher ISS-6020/ISS-6020G, connect No. 1,2,6,7,9 and15 pins of the projector to the same No. pins of the switcher as shown below.

### Pin Configuration of Optional CTL-6010 Cable

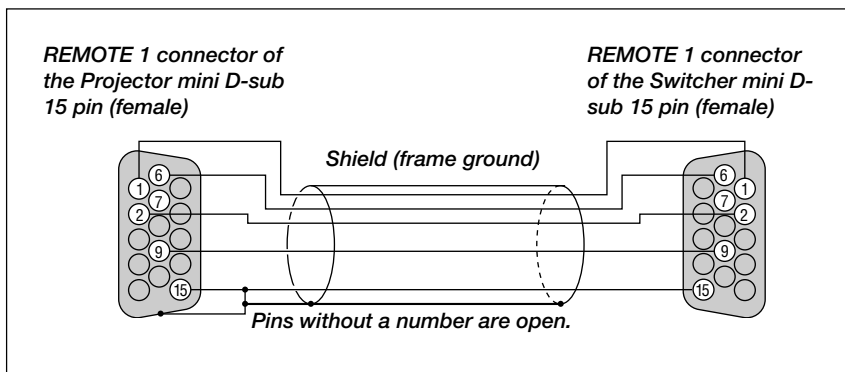

**When used in stand alone operation.**

Pin No.	SHORT/OPEN				FUNCTION
14	SHORT OPEN				External control mode ON External control mode OFF
5	SHORT OPEN				POWER ON POWER OFF
10	SHORT OPEN				PICTURE MUTE ON PICTURE MUTE OFF
4,8,12,11	11pin	12pin	8pin	4pin	
	OPEN	OPEN	OPEN	OPEN	RGB 1 (INPUT 1)
	OPEN	OPEN	OPEN	SHORT	VIDEO 1 (INPUT 5)
	OPEN	OPEN	SHORT	OPEN	S-VIDEO 1 (INPUT 7)
	OPEN	OPEN	SHORT	SHORT	COMPONENT (INPUT 4)
	OPEN	SHORT	OPEN	OPEN	SDI (INPUT 0)
	OPEN	SHORT	OPEN	SHORT	RGB 2 (INPUT 2)
	OPEN	SHORT	SHORT	OPEN	VIDEO 2 (INPUT 6)
	OPEN	SHORT	SHORT	SHORT	S-VIDEO 2 (INPUT 8)
	SHORT	OPEN	OPEN	OPEN	RGB (DIGITAL) (INPUT 9)
	SHORT	OPEN	SHORT	OPEN	RGB 3 (INPUT 3)

- \* When the combinations other than specified in the above table are selected, the input will be forcefully switched to RGB 1.
- \* The term "SHORT" means to connect with pin 15
- \* When in the external control mode, the POWER, INPUT, PICTURE MUTE and SOUND MUTE buttons on the remote control will not function.

**NOTE:** Pin 13 is the external remote signal terminal. The projector can be controlled by the same format signal as the supplied remote control from the external controller regardless of setting on Pin 14.

**NOTE:** When turning off the power to the projector using the external control, do not disconnect the plug from the power outlet. These procedures are to protect your projector and the connected equipment.

---

## Operating Multiple Projectors with the Remote Control

You can operate multiple projectors with the same remote control in wireless operation.  
To do so:

1. Select [Menu] → [Projector Options] → [Setup] → [Page 5] → [Projector ID] and assign an ID number to each projector. See also page E-39.
2. On the remote control specify the ID number of the projector to be adjusted. Press and hold the CTL and press MENU (ADDRESS) button to enter the ID number.  
You can operate the projector assigned the same ID number as the remote control.

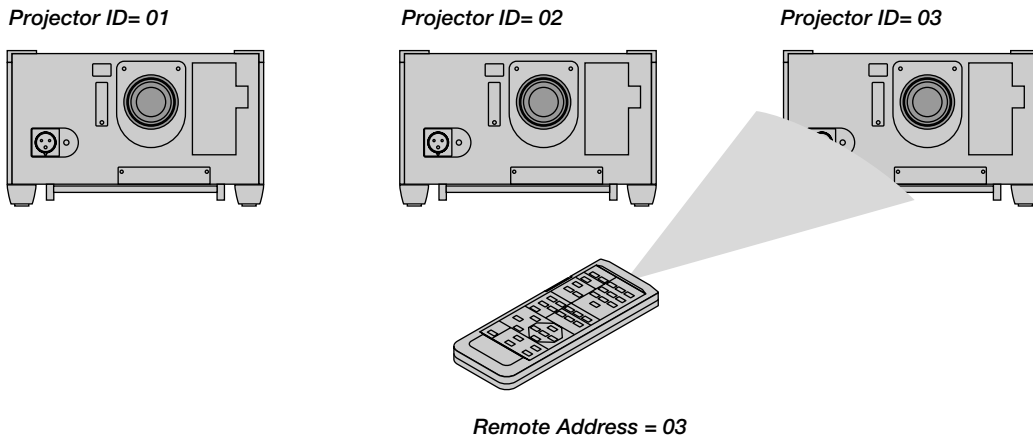

You can daisy-chain multiple projectors and operate them separately with the same remote control in wired operation.

To do so:

1. Use the remote control cable to connect the REMOTE 2 Output of one projector to the REMOTE 2 Input of the next projector until all the projectors are connected. Only one remote control cable is supplied with each projector.
2. Specify a unique projector ID for each projector.
3. Specify the same remote address as the projector ID to be adjusted.

**NOTE:** Specifying "None" for projector ID allows you to operate multiple projectors concurrently. However, some projectors may not synchronize to the other projectors.

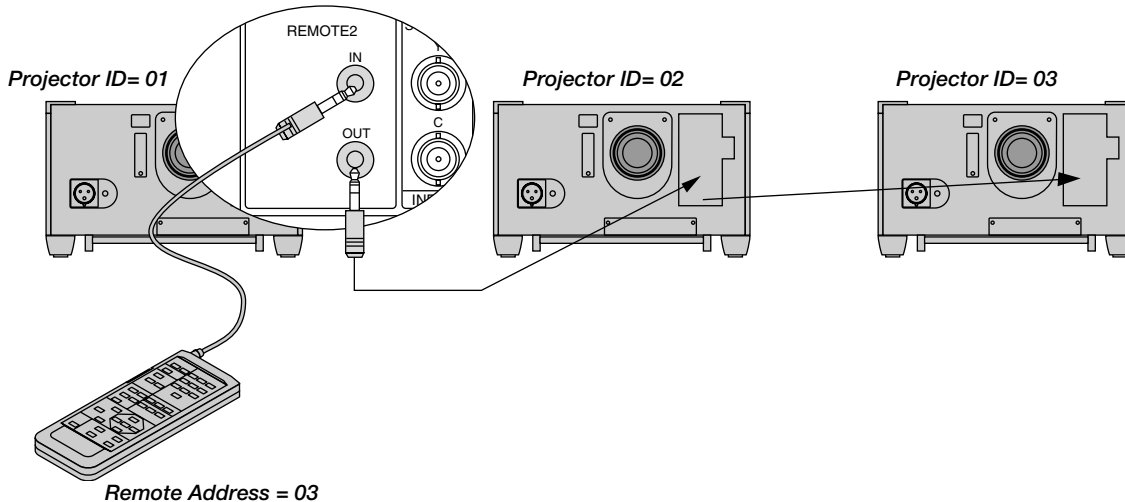

## Using the RGB DIGITAL connectors

The Link mode function allows you to adjust or set multiple projectors using the RGB DIGITAL and OPTION connectors. The DVI DIGITAL input accepts up to the SXGA (1280 x 1024 @ 75Hz) signal in Link mode.

**NOTE:** The Auto Adjust feature does not work for DVI digital signal. When DVI signal is selected and the image position is not corrected, adjust the horizontal and vertical position using the Position screen. See page E-33 for more details.

### Connection for Double Stacking in Link Mode

Connect source equipment to the master projector.

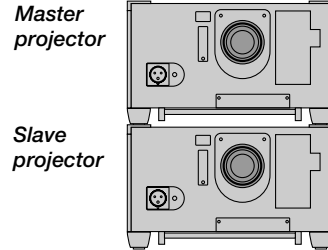
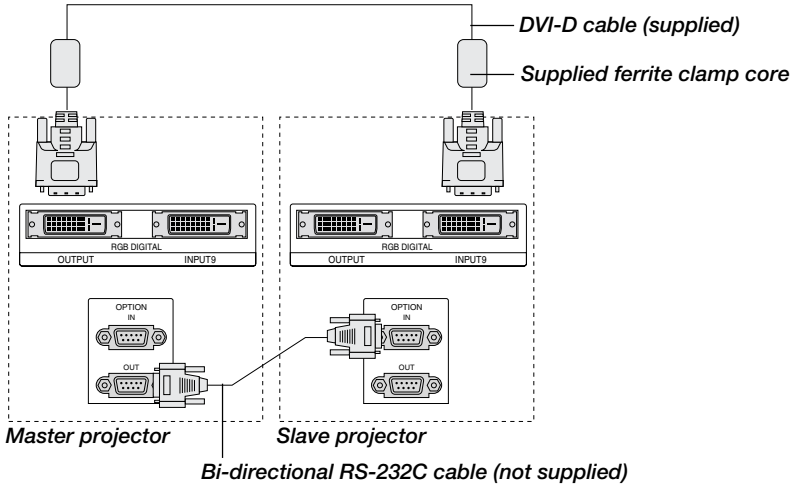

**NOTE:**

- \* Use the supplied DVI-D cables for stacking.
- \* The end with the ferrite core should go to the RGB DIGITAL OUTPUT of the projector.
- \* Specify the DVI-D type when you buy DVI cable. When you use commercially available DVI cables, they must be 5 m (16.4 feet) or less in length.

It is recommended that you use a commercially available distribution amplifier if you use signals other than VGA (640X480@60Hz) to SXGA (1280X1024@75Hz) in Link mode.

### Link Mode

You can daisy-chain up to 16 projectors and operate them separately with the same remote control in wired operation.

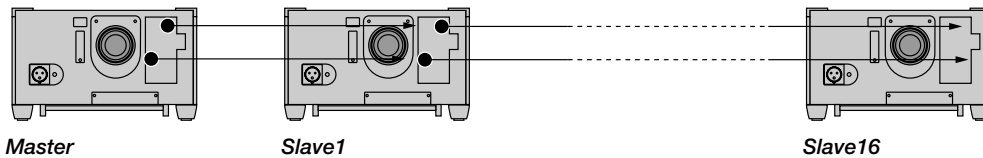

### Connecting a PC with the RGB digital connector

Connect the RGB DIGITAL IN connector of the projector to a digital connector of your computer.

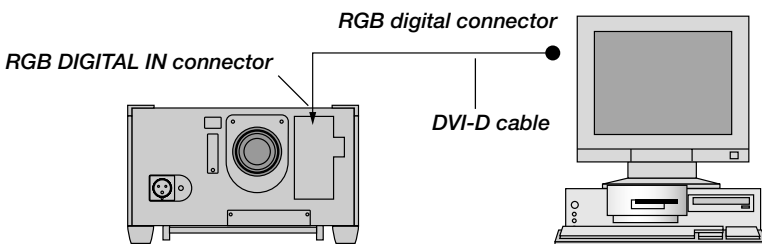

### Information for Reducing Radiation of Electromagnetic Waves

To reduce unnecessary radiation of electromagnetic waves, use the supplied ferrite clamp core,

#### Installation Instructions

1. Open and attach the ferrite clamp core to the supplied DVI-D cable as close as possible to the end that goes to the projector.

\* Push the catch to open the ferrite clamp core.

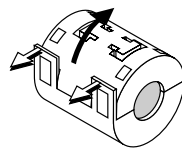

2. Close the ferrite clamp core tightly.

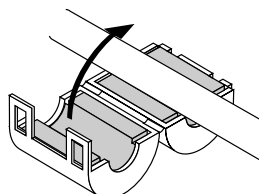

3. Fix the supplied band to the cable as a stopper.

\* Pull the end of the band to tighten it. Cut off the surplus of the band.

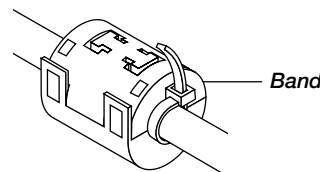

**NOTE:** Be sure to use the ferrite clamp core at the end of the DVI-D cable.

# 5. OPERATION

---

This section describes how to select a computer or video source, adjust the picture and sound, edit a signal and adjust all other settings and adjustments for proper projector set-up.

## General Controls

Before you turn on the projector ensure that the computer or video source is turned on and that the lens cap is removed.

### 1. Turn On The Projector

Plug the supplied power cable into the AC outlet. The main power switch is on the front panel of the projector. By pushing up this switch, the projector will go into its standby mode and the POWER indicator will glow orange. Only after you press the 'POWER ON' button on the remote control or projector cabinet will the POWER indicator turn to green and the projector will fully turn on.

### 2. Select The Computer Or Video Source

Press the INPUT button on the remote control to select the desired source. Or press the MENU button on the remote control and use the Source Select to select your video source: Video, S-Video, RGB, Y/Cr/Cb, RGB Digital or SDI.

### 3. Adjust The Image

Press the ADJUST PICTURE button or the ADJUST WHITE BAL on the remote control or select the [Menu] → [Adjust (Source)] to adjust the picture.

### 4. Turn Off The Projector

First press the POWER OFF button on the remote control or the projector cabinet. Allow the fan to cool the projector for three minutes. This will extend the life of the lamp. After the cooling fan stops working, the POWER indicator will change to a steady orange glow and the projector will be in the stand-by mode. Then push down the main power switch on the front panel. The POWER indicator will go out. If you desire to move the projector then unplug the power cable.

## IMPORTANT:

- The projector will turn off and go into the standby mode after 850 hours of service.
- The projector should be unplugged if it will not be used for an extended period.
- If you want to turn off the image briefly (five minutes or less), press the MUTE PICTURE button instead of turning the projector off and on.
- The projector will display a black, blue image or logo if no input signal is present.
- Do not turn the projector off and then immediately back on. The Projector needs to cool down for three minutes before it is powered on again.

---

**CAUTION:** Do not turn off the main power while the cooling fan is working.

---

## Using The Menus

1. Press the MENU button on the remote control to display the menu.
2. Use the ▲ or ▼ button on the remote control to select the sub menu.
3. The right-oriented delta symbol indicates further choices are available. Press the ► button to highlight the item you want to adjust or set in the selected menu.
4. Press the ▲ or ▼ button on the remote control to select the item.
5. Press the ENTER button on the remote control to display the adjustment screen or dialog box.
6. Adjust the level or turn the selected item on or off by using ◀ or ▶ on the remote control. The on-screen slide bar will show you the amount of increase or decrease.

---

**NOTE:** The change is stored automatically when any one of the following procedures is performed:

- \* The on-screen disappears.
  - \* The projector goes into standby.
  - \* One input is switched to another.
- 

7. Repeat steps 2-5 to adjust an additional item, or press the CANCEL button on your remote control to quit.

## Shutter mechanism

The projector is equipped with "Shutter" feature, which allows the user to shut off the light completely on the screen. To use the shutter function, hold down the CTL button, and press the MUTE PICTURE button on the remote control.



## Customizing Basic/Custom Menu

The Basic/Custom menu can be customized to meet your requirements. Selecting a menu item from the "Basic/Custom Menu Edit" list, allows you to custom tailor the menu items to your needs.

1. Select "Basic/Custom Menu Edit" to display the "Basic/Custom Menu Edit" screen.

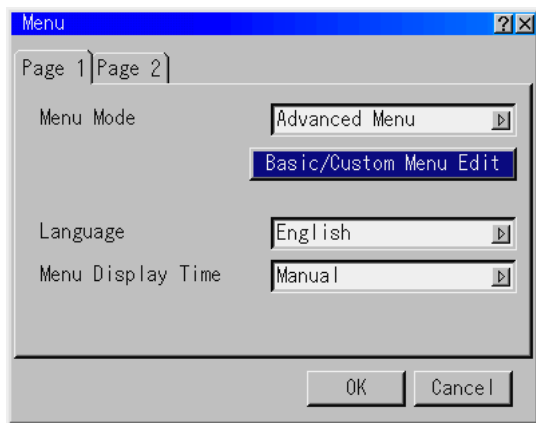

2. Use the ▲ or ▼ button to highlight your selection and press the Enter button to place a check mark next to an option. This action enables that feature. Press the Enter button again to clear the check box.

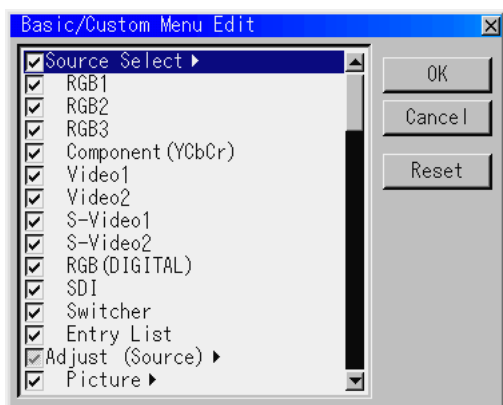

If you select an item with a solid triangle ► and press the Enter button on the remote control or the projector cabinet, you can enable all the items within that submenu. Also you can turn on an item within the submenu without placing a check mark on the main menu item.

**NOTE:** Up to 12 main menu items (within Basic/Custom Menu Edit, not including submenu items) can be selected.

3. In order for the changes to take effect, use the ◀ or ▶ button on the remote control or the projector cabinet to highlight "OK", then press the Enter button. To cancel the changes, use the ▲ or ▼ buttons to highlight "Cancel" and press the "Enter" button. To return to the factory default, select "Reset" then press the "Enter" button. The default Basic/Custom Menu items are: Source Select (RGB1/2/3, Component (Y/Cb/Cr), Video1/2, S-Video 1/2, DVI digital, and SDI), Brightness, Contrast, Pixel Adjust and Position.

**NOTE:** Once you have selected OK on the Basic/Custom Menu Edit screen, you cannot cancel the changes on the Menu screen. However, you can re-edit the menu items over again as described in the steps above.

**NOTE:** If the "Advanced Menu" item has been selected on the Menu mode, you get the "Confirmation Change Menu" upon completion of "Basic/Custom Menu" editing. In this case, selecting "Yes" then "Enter" will close all the menus and apply the changes from the Advanced menu to the Basic/Custom Menu. If you select "No" then "Enter" functions, then all menu items will return to the Advanced menu, but your changes will still be available within the "Basic/Custom Menu" selection. To display the previously tailored Basic/Custom Menu, select "Basic/Custom Menu" from the "Menu Mode".



An item "To Advanced Menu" will be added to the bottom of the Basic/Custom Menu. Selecting this item and pressing the "Enter" button will display the "Advanced Menu" features.

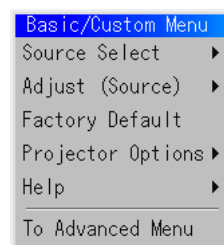

## A List of Direct Key Combinations

CTL+ INPUT (1-10)	Switches to any selected signal found in the Entry List. To enable this combination, you must first assign specific remote keys for direct input selection in the Entry Edit window.
CTL+ ENTER (While displaying Entry list)	Displays the Entry Edit Command window.
CTL+ MUTE PICT/SHUT	Blocks all Projector Light Output.
CTL+CANCEL	Returns to the previous menu without closing the sidebar or dialog.
CTL+ UNDO	Clears all menus or adjustment/setting screens. All adjustments are saved automatically.
CTL+ ◀/▶/▲/▼	Moves the sidebar or dialog box horizontally or vertically.
While using zoom on remote control:	Displays the magnifying glass icon.
CTL+ ◀	Deletes one letter or numeral in the entry screen.
CTL+MUTE OSD	Turns off the on-screen display. Press again to turn on the on-screen display.
INPUT(1-10) in SW Level mode	Displays the Select switcher Input Slot window. <b>NOTE:</b> This feature is available for SW 2 Level mode only. When the SW 1 Level mode is selected, pressing INPUT key switches to the corresponding slot without displaying the Select Slot window.
CTL+ MENU/ADDRESS	Displays the remote ID entry window.
CTL+ IMAGE/PROJECTOR	Sequentially selects the Projector Options sub menu.
CTL+ POSI/LENS	Displays the Lens Shift control window.
CTL+ KEYST/R	Turns on red. Available only when the projector is in the test pattern mode.
CTL+ AMP/G	Turns on green. Available only when the projector is in the test pattern mode.
CTL+ E-LIST/B	Turns on blue. Available only when the projector is in the test pattern mode.
CTL+ MAGNIFY/ZOOM	Zooms the lens in and out
CTL+ FOCUS	Adjusts the lens focus.

# Menu Tree

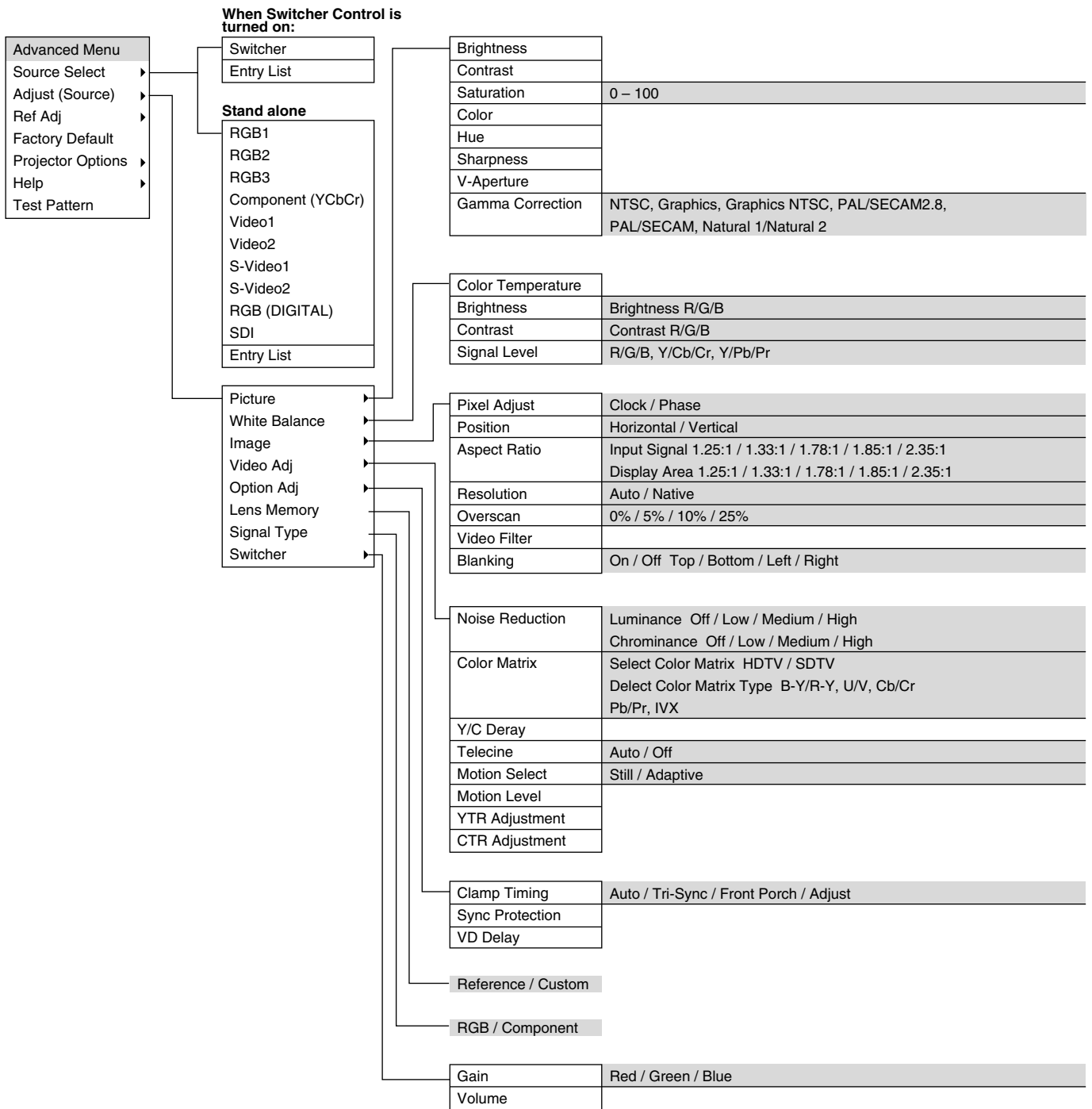

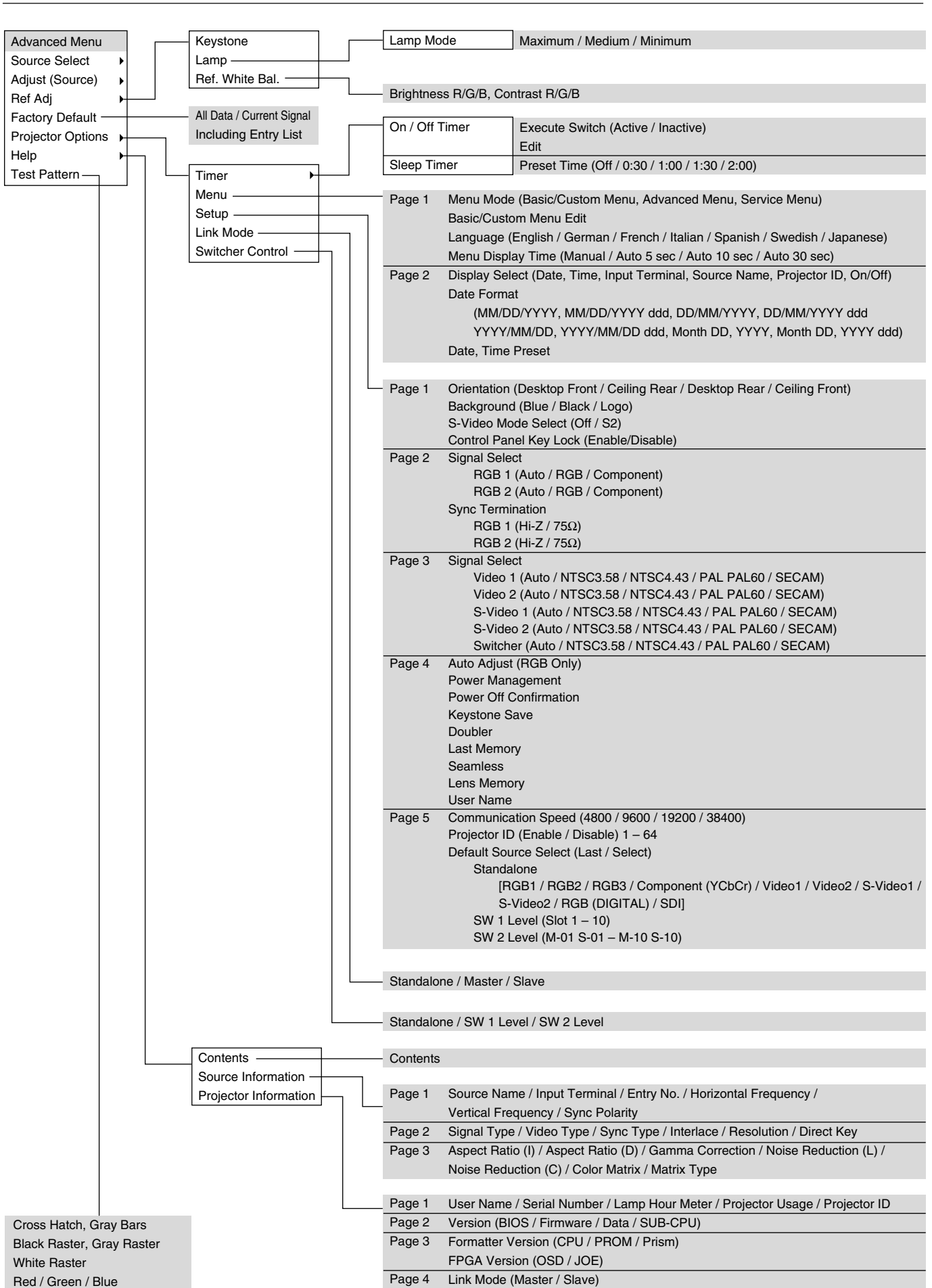

## Menu Elements

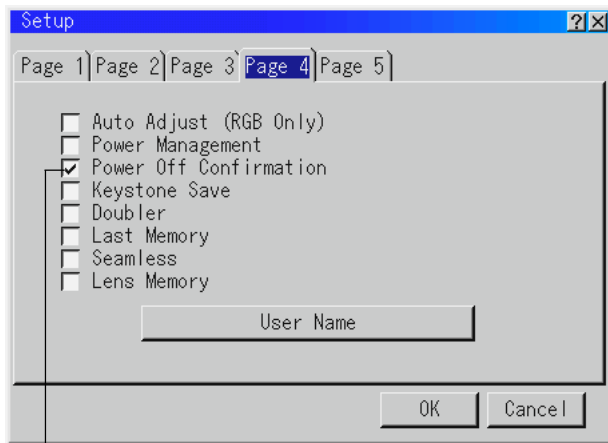
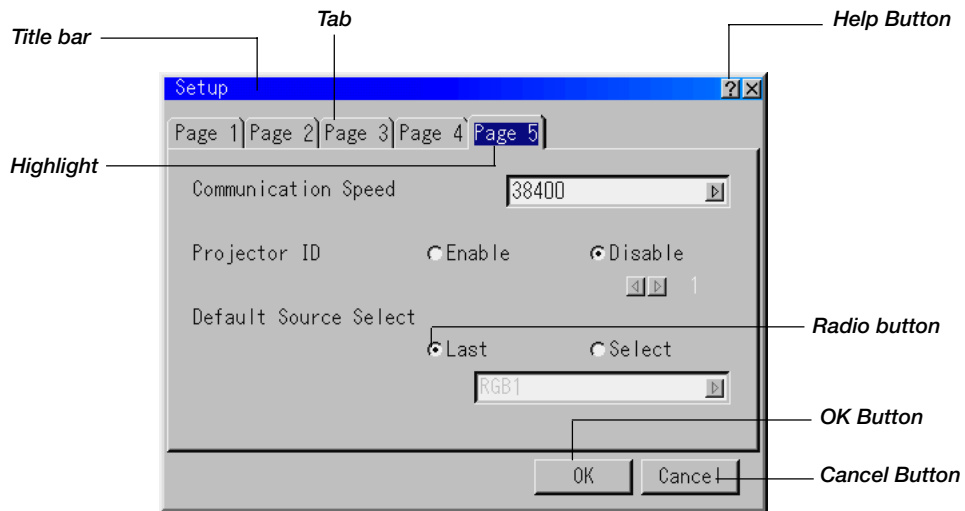

Check box

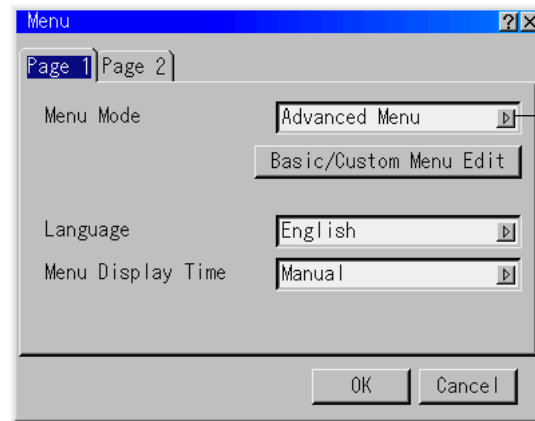

Solid triangle



Slide bar

### Menu windows or dialog boxes typically have the following elements:

- Title bar:** Indicates the menu title.
- Highlight:** Indicates the selected menu or item.
- Solid triangle:** Indicates further choices are available. A highlighted triangle indicates the item is active.
- Tab:** Indicates a group of features in a dialog box. Selecting on any tab brings its page to the front.
- Radio button:** Use this round button to select an option in a dialog box.
- Check box:** Place a checkmark in the square box to turn the option On.
- Slide bar:** Indicates settings or the direction of adjustment.
- OK button:** Press to confirm your setting. You will return to the previous menu.
- Cancel button:** Press to cancel your setting. You will return to the previous menu.
- Help button:** Press the Help button on the remote control to display help.

## Menu Descriptions & Functions

### Source Select

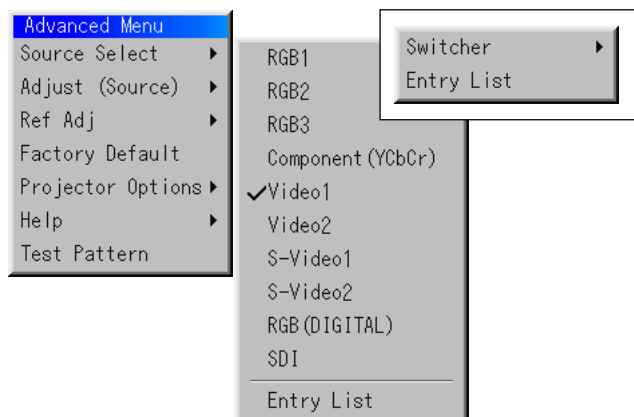

Enables you to select a video source such as a VCR, DVD player, laser disc player, computer or document camera depending on what is connected to your inputs.

Press the up/down buttons on your remote control or the projector cabinet to highlight the menu for the item you want to adjust.

- \* RGB1,2,3
- \* Component (YCbCr)
- \* Video 1, 2
- \* S-Video 1, 2
- \* RGB (Digital)
- \* SDI

### Swicher

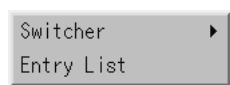

You can select the slot number from 1 to 10 of the Switcher(s) ISS-6020.

When using with a single Switcher ISS-6020:

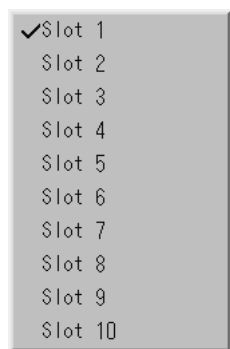

Use the SELECT ▲ or ▼ button to select the desired slot number from 1 to 10 of the ISS-6020 Swicher and press ENTER.

When using with two or more Switcher ISS-6020:

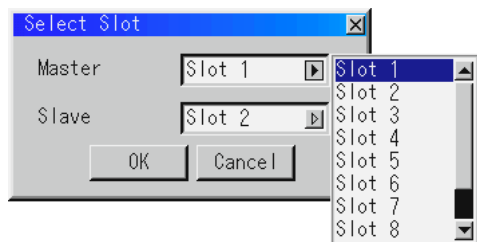

Use the SELECT ▲ or ▼ button to select the master slot number from 1 to 10 and then the slave slot number from 1 to 10 on the Select Slot menu. Select OK and press ENTER. To close the window without storing the settings, select Cancel and press ENTER.

### Entry List

Displays the list of the entry signals. Use the ▲▼ buttons on your remote control or the projector cabinet to select the signal and press the ENTER button on the remote control or the projector cabinet to project the image of the selected source.



### Entry Edit Command

You can edit the signal on the entry list.

To do so:

1. While pressing and holding CTL, press ENTER on the remote control to display the Entry Edit Command window.



- \* **Cut** Enables you to remove a selected signal from the list and place it on the "clipboard" in the projector.
- \* **Copy** Enables you to copy a selected signal from the list and place it on the "clipboard" in the projector.
- \* **Paste** Enables you to paste the signal placed on the "clipboard" to any other line of the list. To do this, select "Paste" and then select the line number you want to paste to. Last press ENTER.
- \* **Edit** Enables you to change source name or assign the direct key.
- \* The following buttons are not available for the currently projecting signals:

- 1) The Cut and Paste buttons on the Entry Edit Command screen
- 2) The Input Terminal button on the Entry Edit screen

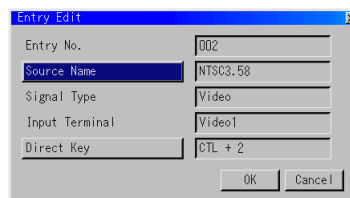

When complete, select OK and press ENTER. To exit without storing setting, select Cancel.

Select "Source Name" and press ENTER to display the Source Name Edit window. You can change source name on this window. Select "Input Terminal" and press ENTER to display the Input Terminal window. You can change input terminal on this window. RGB1, RGB2, RGB3, and RGB(DIGITAL) can be selected for RGB signals; RGB1, RGB2, Component, and RGB(DIGITAL) can be selected for component signals; Video 1/2, S-Video 1/2, and RGB(DIGITAL) can be selected for Video and S-Video signals.

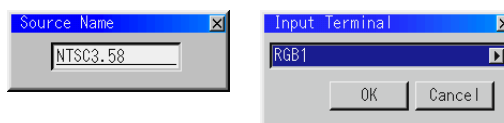

Select "Direct Key" and press ENTER to display the Direct Key window.

You can assign specific remote keys for direct signal input selection.

**NOTE:** Existing direct key settings are overwritten with new settings.

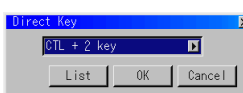

Select "List" and press ENTER to display the direct Key assignment list.  
 Select "OK" and press ENTER to close the window.  
 To close the List window, press CANCEL on the remote.



## Adjust (Source)



### Picture



#### Brightness

Adjusts the brightness level or the back raster intensity.

#### Contrast

Adjusts the intensity of the image according to the incoming signal.

#### Saturation

Adjust saturation at the white peak.

### Color

Increases or decreases the color saturation level (not available for RGB).

### Hue

Varies the color level from +/- green to +/-blue. The red level is used as reference. This adjustment is only valid for Video and Component inputs (not available for RGB).

### Sharpness

Controls the detail of the image for Video (not available for RGB and Component).

### V-Aperture

Adjusts edge enhancement in the vertical direction. (not available for RGB)

### Gamma Correction

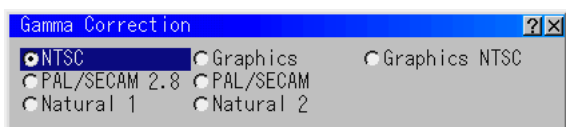

This option corrects gamma. Select the appropriate item.  
 NTSC ..... Setting for NTSC signals  
 Graphics ..... Setting for Computer Graphics  
 Graphics/NTSC ..... Setting for both Computer Graphics and NTSC signals (Default value)  
 PAL/SECAM 2.8 ..... Setting for PAL and SECAM signals at the gamma value of 2.8  
 PAL/SECAM ..... Setting for PAL and SECAM signals  
 Natural 1 ..... Setting for Video and S-Video signal  
 Natural 2 ..... Setting for component signal (γ value 2.2)

## White Balance

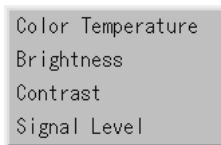

### Color Temperature

This feature adjusts the color temperature using the slide bar. Move the slide bar to the right to increase the color temperature for a bluish image; to the left to decrease it for a reddish image.

### Brightness

Brightness for each color (RGB) is used to adjust the black level of the screen.

### Contrast

Contrast for each color (RGB) to adjust the white level of the screen.

### Signal Level

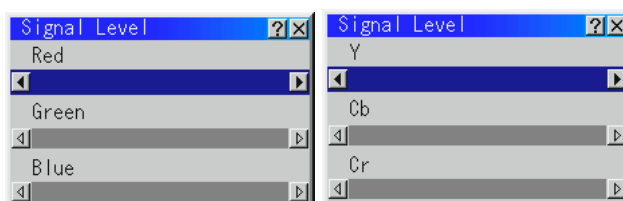

#### R/G/B, Y/Cb/Cr or Y/Pb/Pr Gain:

Adjust RGB, Component or HDTV Gain to match multiple projector color uniformity.

## Image

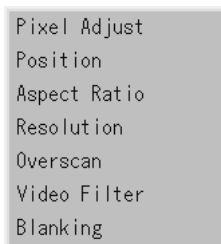

### Pixel Adjust (when Auto Adjust is off)

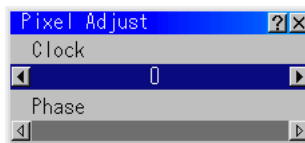

Displays the Clock and Phase adjustments.

Clock ..... Use this item with the "Auto Adjust off" to fine tune the computer image or to remove any vertical banding that might appear.

Phase ..... Use this item to adjust the clock phase or to reduce video noise, dot interference or cross talk. (This is evident when part of your image appears to be shimmering.) Use the ◀ and ▶ buttons to adjust the image.

Use "Phase" only after the "Clock" is complete.

**NOTE:** When Auto Adjust is turned ON on the Page 4 of Setup, the Clock adjust is not available on this Pixel Adjust screen.

**Horizontal/Vertical Position (when Auto Adjust is off)**

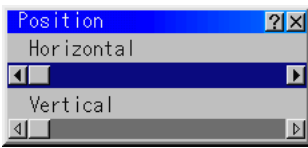

Adjusts the image location from left to right.  
This adjustment is made automatically when the Auto Adjust is turned on.

**Aspect Ratio (not available for RGB)**

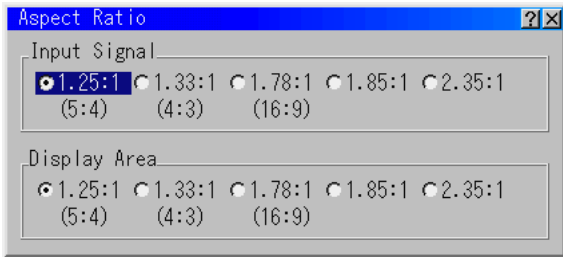

You can select the aspect ratio for input signal and display area respectively.  
Select the appropriate aspect ratio using the SELECT ◀, ▶, ▲, or ▼ button.

**NOTE:** When "Resolution" is set to "Native", this feature is not available, and the stored settings and adjustments are invalid.

**Resolution (when Auto Adjust is off)**

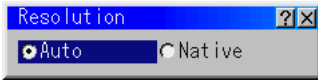

This allows you to activate or deactivate the Advanced AccuBlend feature.

Auto ..... Turns on the Advanced AccuBlend feature. The projector automatically reduces or enlarges the current image to fit the full screen.

Native ..... Turns off the Advanced AccuBlend feature. The projector displays the current image in its true resolution. See "Auto Adjust (RGB Only)" on page E-38 for turning on or off the Auto Adjust feature.

**NOTE:** While you are displaying an image with higher resolution than the projector's native resolution (SXGA:1280 x 1024), even when you are in the Native mode, the image is displayed full screen using the Advanced AccuBlend feature.

**NOTE:** The image with lower resolution than SXGA(1280 x 1024) is displayed in small when you are in the Native. In this case, you can use the lens shift, zoom and focus adjustments, which you saved in advance with "Custom" of "Lens Memory", to enlarge the image to fit on the screen.

**Overscan**

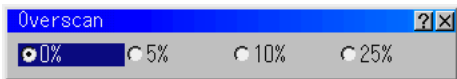

You can select overscan percentage for RGB signal.  
Select the appropriate option using the SELECT ◀ or ▶ button.

**NOTE:** When "Resolution" is set to "Native", this feature is not available, and the stored settings and adjustments are invalid.

**Video Filter**

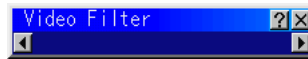

This feature reduces video noise. Select the appropriate filter for your signal.

- Bar 0 ..... Off
- Bar 1/3 ..... High
- Bar 2/3 ..... Medium
- Bar full ..... Low

**Blanking**

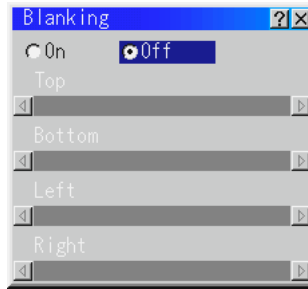

This feature allows you to mask any unwanted area of the screen image.

Blanking On/Off:  
This setting enables or disables the blanking function.

- On ..... Blanking function is enabled.
- Off ..... Blanking function is disabled.

\* Adjustment of vertical display range

Adjust the Top, Bottom, Left or Right blanking with the SELECT ◀ or ▶ button.

**Video Adj**

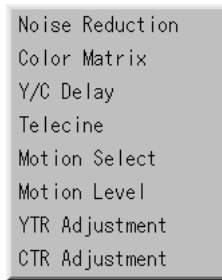

**Noise Reduction**

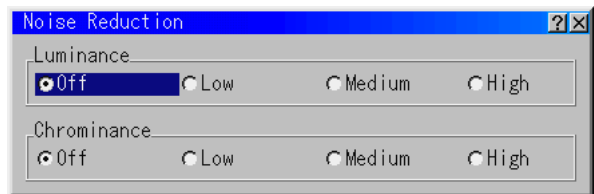

Select one of the following three levels for reducing video noise. Low, Medium or High.

**NOTE:** The lower the Noise Reduction level, the better the image quality. Increasing Noise Reduction lowers video bandwidth.



## Color Matrix

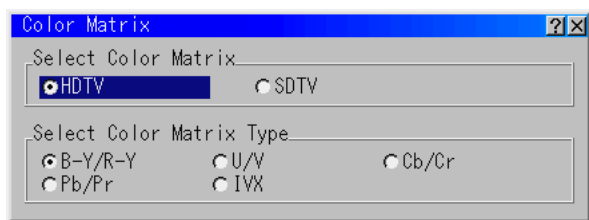

First, select an appropriate color matrix for your input signal, either HDTV or SDTV. Then select an appropriate matrix type from B-Y/R-Y, Cb/Cr, Pb/Pr or IVX.

**NOTE:** The Color Matrix feature is available for component video signal only.

## Y/C Delay (not available for RGB)



Adjusts Y/C delay level.

## Telecine



Use 3:2 pull down correction to eliminate jitter and artifacts in video.

Auto ..... For film source such as a DVD player  
Off ..... For signals other than film sources

## Motion Select

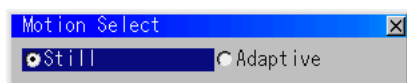

Sets the interpolation method. Selects Still or Adaptive. Still is used for non moving images such as a document camera. Select Adapter for all motion video.

## Motion Level



Adjusts level of motion detection when Adaptive is selected.

## YTR Adjustmen (not available for RGB)

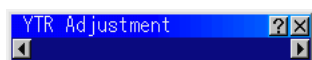

Adjusts luminance transient time.

## CTR Adjustment (not available for RGB)

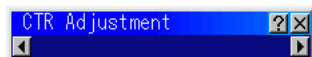

Adjusts chroma transient time.

## Option Adj

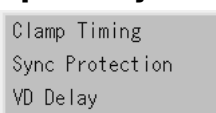

## Clamp Timing

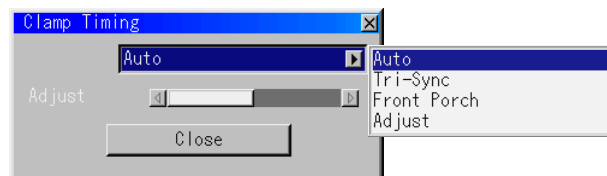

According to the signal, this function sets the detection position (i.e., clamp position) of the black level reproduction of the analog input signal. Normally this is not used. (1080P is set as the default)

Auto ..... This is the normal setting.  
Tri-Sync ..... This is set when projecting HDTV video.  
Front Porch .. This is set when the picture quality does not improve even though Auto or Tri-Sync has been set.  
Adjust ..... This permits the video clamp position for each signal to be set. Use "Adjust" when a clamp timing error occurs at the time of special analog signal reception such as 1080P. Note that "Adjust" is not valid for doubler signals such as NTSC and PAL.

To delete the "Clamp Timing" setting screen, select the SELECT ▼ button and press the ENTER button, or press the remote control CANCEL button.

## Sync Protection

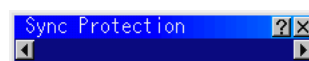

When a VCR, DVD, or some other equipment that supports Copyguard (a copy prevention system) is played back, the screen may be displayed in a curved manner. Adjustments are made in such circumstances. Use the SELECT ◀ or ▶ button to adjust the VD level.

## VD Delay



This feature is used to correct vertical jitter of non-standard interlaced signal.

**NOTE:** When connecting with a scan converter:  
If an image from the scan converter is not correctly displayed, adjust to select the best level point so that the image is displayed correctly.

## Lens Memory



This function serves to store the adjusted value when using the Shift, Focus, and Zoom buttons of the main unit or the remote control.

### Usage Example

When you wish to display on a screen having a 4:3 aspect ratio an NTSC or other 4:3 aspect ratio signal and an SXGA or other 5:4 aspect ratio signal:

Perform shift, focus, and zoom adjustments to set the vertical screen size of the vertically long 5:4 aspect ratio signal to standard. Both 4:3 aspect ratio signals and 5:4 aspect ratio signals can now be displayed.

Note that with these shift, focus, and zoom adjustments, the 4:3 aspect ratio signal will become smaller on the screen.

To eliminate this size reduction, adjust the shift, focus and zoom to the optimum condition for each of the 4:3 aspect ratio signal and the 5:4 aspect ratio signal. Memory (storage) of each of these values will permit projection at an optimum condition upon signal switching.

- 1) Select "Projector Options" → "Setup" → "Page 4" → "Lens Memory" and then insert a check mark into the Lens Memory check box.
- 2) Set to no-signal condition or project a 5:4 aspect ratio signal and then adjust each of shift, focus, and zoom.
- 3) Select "Reference" under "Adjust(Source)" → "Lens Memory" → "Reference/Custom" and store your adjustments.

\* For signals other than those having a 5:4 aspect ratio (or, 5:4 aspect ratio signals that you wish to adjust separately), adjust shift, focus, and zoom, select "Custom" under "Reference/Custom", then press "Store". The differences between "Reference" and "Custom" are described below.

"Reference": Valid adjustment value for a no-signal condition and a newly input signal "Custom": Custom adjustment value for a specific signal

Note that when "Reference" is stored, it will be overwritten since it is not an adjustment that changes with each signal.

In the aforementioned description, signals having a 5:4 aspect ratio are restricted to "Reference", but signals having other aspect ratios can also be used as standard signals.

Another method to store values is to press the INFO button while holding down the CTL button of the remote control.

Note that when using the remote control for storing, storage will be in "Reference" when the "Lens Memory" setting of the menu is "Reference", and storage will be in "Custom" when the setting is "Custom". Defaults such as newly input signals are "Reference".

\* See "Tips on Adjusting Focus for Lens Memory Function" on page E-47 for more information.

## Signal Type

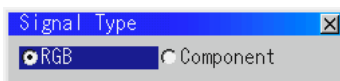

Select either the RGB signal type or the Component signal type.

RGB ..... RGB signal

Component .. Composite signals such as Y/Cb/Cr, Y/Pb/Pr

**NOTE:** This feature is available on RGB 1 and 2 only.

## Switcher (available only when used with ISS-6020)



### Gain

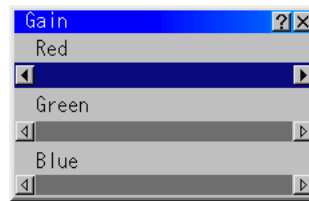

This feature adjusts the input level of the signal. This must be done to each color:R, G, and B.

### Volume



This feature adjusts the volume of the audio output. Adjust the sound corresponding to the slot.

## Ref Adj

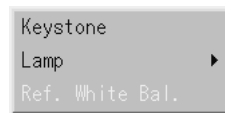

### Keystone



This feature corrects the keystone (trapezoidal) distortion to make the top of the screen longer or shorter to be the same as the bottom. Use the ◀ or ▶ buttons on the slide bar to correct the keystone (trapezoidal) distortion.

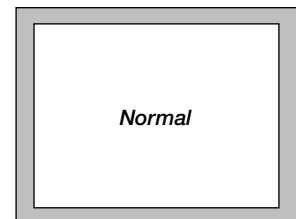
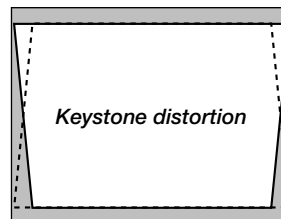

### NOTE:

1) With the projector aimed directly at the screen the maximum keystone angle that can be corrected is +/- 7.5 degrees.

2) When "Resolution" is set to "Native", this feature is not available, and the stored settings and adjustments are invalid.

Depending on the type of graphics being used, the picture may get blurred or keystone correction may not be possible when excessive keystone correction is used.

The idea is, the closer you are to native resolution, the better image you will see.

**NOTE:** The keystone feature is not available when the test pattern or the blue back is displayed.

## Lamp



### Lamp Mode

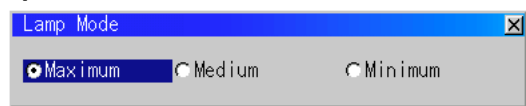

This feature allows the lamp power supply to operate under three settings.

Maximum ..... This setting consumes maximum current from the AC input and results in the most light output.

**NOTE:** The Maximum mode shortens the lamp life. Be sure to use this mode at temperature of 95° F (35°C) or less.

Medium ..... This setting allows the lamp power supply to draw a medium amount of current from the AC input source and allows for medium power consumption.

Minimum ..... This setting consumes minimum current from the AC input and results in the least light output.

## Reference White Balance

This feature adjusts the white balance that is used as a reference. This adjustment affects all sources. The Ref.White Bal. is available for test pattern only.

## Factory Default

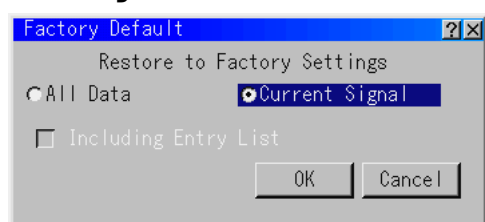

Returns all adjustments and settings to the factory preset level.

All Data ..... Reset all the settings for all the signals to the factory preset.

**NOTE:** The items that can be reset are all the settings and adjusts except for Language, Projector ID, Lamp Hour Meter, Projector Usage and Communication Speed.

*Including Entry List*  
Also deletes all the signals in the Entry List and returns to the factory preset.

Current Signal ..... Resets the adjustments for the current signal to the factory preset levels.

**NOTE:** All the items in "Adjust (Source)" can be reset.

## Projector Options

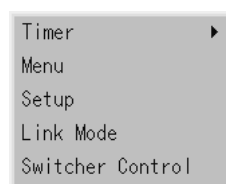

Enables you to set preferences and other operating options.

### Timer

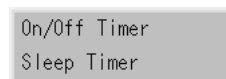

Enables you to turn on or off your projector automatically at a specified time. Two timer functions are available: On/Off Timer and Sleep Timer.

### On/Off Timer



Up to eight settings can be programmed.

- Before setting On/Off Timer, make sure that Date, Time Preset feature is set.
- Even after setting On/Off Timer, turning the projector on or off with the remote control is possible.
- There are two time display formats: 24-hour or AM/PM format.

1. Open the On/Off Timer window.
2. Select EDIT and press ENTER on the remote control to open the EDIT window.

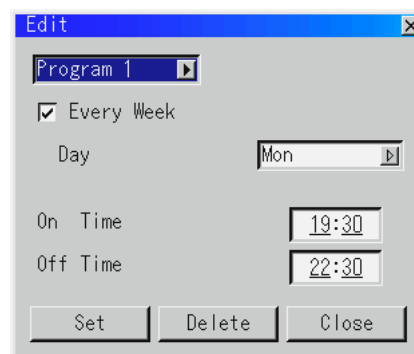

3. Set the Week, Day, On-Time and Off-Time using the Select buttons and Source buttons (1 thru 10). To cancel the on-time or off time, use Delete.
4. Select Set and press the ENTER button on the remote control to complete the setting. To close, select Close.

- To enable your setting, select Active on the Execute Switch.
- Select OK and press the ENTER button on the remote control to complete the setting.

**NOTE:** When On Timer is set and the projector is in the standby mode, the Status indicator flashes green to show that On Timer program is active. The projector must be in stand-by mode at the time of turning on. The preset power-on time will be void if the cooling fan is working or an error occurs. Unplugging the projector cancels your 1 Week programs regardless of whether the program was executed or not. However, your Every Week program will not be cancelled even if you unplug the projector.

### Sleep Timer

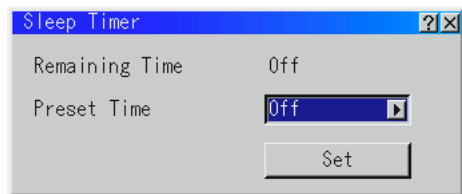

- Select your desired time between 30 minutes and 2 hours in 30 minute increments.
- Select Set and press the ENTER button on the remote control.
- The remaining time starts counting down.
- The projector will turn off after the countdown is complete.

### Menu

[Page 1]

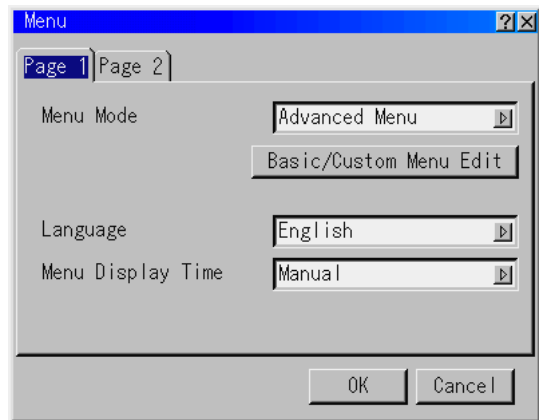

Allows you to set preferences for the on-screen menu. Press "OK" to save your changes for all the features.

#### Menu Mode

This feature allows you to select two menu modes: Advanced Menu and Basic/Custom Menu.

- Advanced Menu ..... This is the menu that contains all the available menus and commands.
- Basic/Custom Menu .... This is the menu that you can customize using the Basic/Custom Menu Edit to fit your needs.

The factory default Basic/Custom menu includes:  
Source Select (RGB1/2/3, Component(Y/Cb/Cr), Video1/2, S-Video1/2, RGB (Digital), and SDI), Brightness, Contrast, Pixel Adjust and Position. See page E-26 for instructions about how to customize the Basic/Custom Menu.

#### Language

You can choose one of seven languages for on-screen instructions. The options are: English, German, French, Italian, Spanish, Swedish and Japanese.

### Menu Display Time

This option allows you to select how long the projector waits after the last touch of a button to turn off the menu. The preset choices are "Manual", "Auto 5 sec", "Auto 10 sec", and "Auto 30 sec". The "Manual" is the factory preset.

- Manual ..... The menu can be turned off manually.
- Auto 5 sec .... The menu will automatically be turned off in 5 seconds if no buttons are pressed within 5 seconds.
- Auto 10 sec .. The menu will automatically be turned off in 10 seconds if no buttons are pressed within 10 seconds.
- Auto 30 sec .. The menu will automatically be turned off in 30 seconds if no buttons are pressed within 30 seconds.

[Page 2]

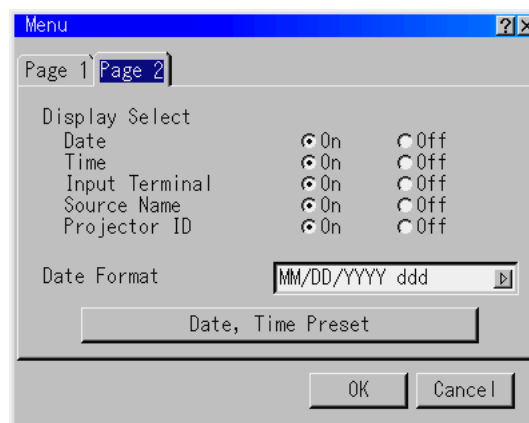

#### Display Select

You can choose the desired status information to be displayed on the screen. The desired status information will be displayed each time you switch between sources.

#### Date Format

Eight display formats can be selected. This date format sets the current date that appears on the upper left corner of the screen.

#### Date, Time Preset

Setting the Current Date and Time



You can set the current time, month, date, and year.

- Type in date.  
Enter month, date and year in this order using INPUT buttons on the remote control. Month and date must be entered in two digits. For example, to display "February", press "0" and "2".
- Type in time.  
Time is expressed in the 24-hour format. For example, 6:00 p.m. is entered as 18:00.
- Select "OK" and press ENTER.  
Closing the window allows the clock to start. The current year, month, date and time are displayed on the top of the screen.

**NOTE:** The projector has a built-in clock. The clock will keep working for about 3 days after the main power is turned off. If the main power is off for 3 days or more, the built-in clock will be reset. If the built-in clock is reset, set the date and time again. The built-in clock will not reset while in the standby condition.

## Setup

Enables you to set operating options. Press "OK" to save your changes for all the features of Page1, Page2, Page3, Page 4 and Page5.

[Page 1]

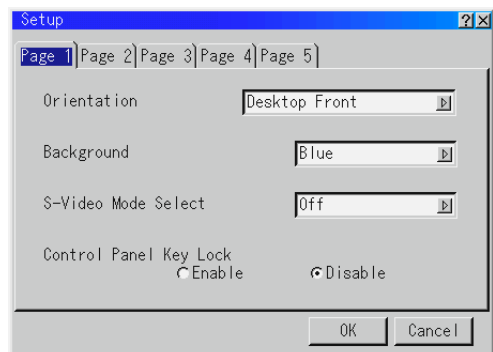

### Orientation

This reorients your image for your type of projection. The options are: desktop front projection, ceiling rear projection, desk-top rear projection, and ceiling front projection.

### Background

Use this feature to display a blue/ black screen or logo when no signal is available. The default background is blue.

### S-Video Mode Select

This feature is used to select the S-Video signal detection mode. This allows identifying of the S-Video signals with different aspect ratio (Zoom signal 16:9, Wide Zoom signal 4:3).

S2 ..... Identifies Zoom or Wide Zoom signal.  
OFF ..... Does not identify any S-video signal.

### Control Panel Key Lock

This option turns on or off the Control Panel Key Lock function. To lock the control panel key functions, select the Enable button. To unlock the control key functions, select the Disable button.

#### NOTE:

- \* This Control Panel Key Lock does not affect the remote control and the PC Control functions.
- \* When the Control Panel Key Lock function is enabled, pressing and holding the CANCEL button for about 10 seconds will disable the setting.

[Page 2]

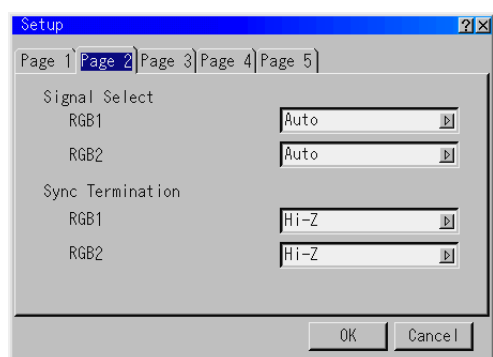

### Signal Select (RGB1/2)

Allows you to choose "RGB" for an RGB source such as a computer, or "Component" for a component video source such as a DVD player. Normally select "Auto" and the projector automatically detects a component signal. However there may be some component signals that the projector is unable to detect. If this is the case, select "Component".

### Sync Termination (RGB1/2)

This functions is used to select the impedance of the sync signal. Select "75 Ω" or "Hi-Z".

**NOTE:** The default setting is "75Ω". This should be "75Ω" for normal use. Select the "Hi-Z" when inputting a TTL signal.

[Page 3]

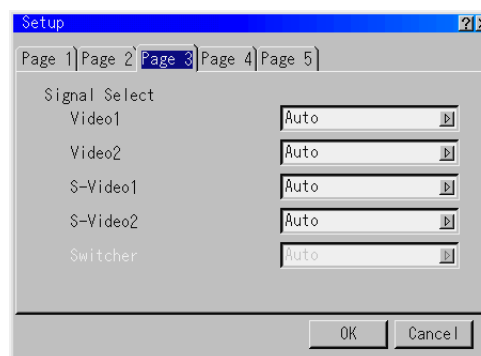

### Signal Select (VIDEO 1/2, S-VIDEO1/2 and Switcher)

This feature enables you to select composite video standards manually. Normally select "Auto". Select the video standard from the pull-down menu. This must be done for Video and S-Video separately. "Switcher" is setting for Video and S-Video in SW 1 Level or 2 mode.

[Page 4]

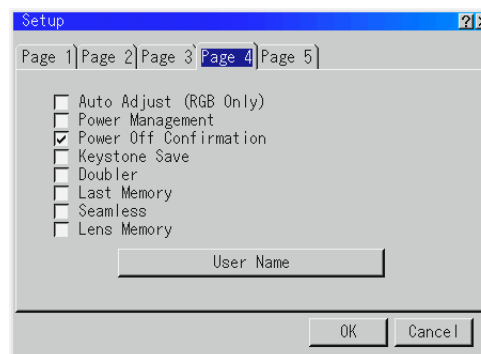

### Auto Adjust (RGB Only)

When "Auto Adjust" is turned on, the projector automatically determines the best resolution for the current RGB input signal to project an image using NEC's Advanced AccuBlend Intelligent Pixel Blending Technology.

The image can be automatically adjusted for position and stability; "Horizontal Position", "Vertical Position" and "Clock".

On ..... Automatically adjusts image display functions ( "Horizontal Position", "Vertical Position" and "Clock".)

Off ..... User can adjust the image display functions ( "Horizontal Position", "Vertical Position" and "Clock") manually.

**NOTE:** The projector has a feature that enters a signal automatically in the Entry List once you made any adjustments. However, this feature is not available if you adjust a signal using the Auto Adjust feature. To register the signal after you use the Auto Adjust feature, first you need to make any one adjustment manually.

### Power Management

When this option is on and there is no RGB input for five minutes or more, the projector will automatically turn itself off.

### Power Off Confirmation

This option determines whether a confirmation dialog for turning off the projector will appear or not.

### Keystone Save

This option enables you to save your current keystone settings.

Saving your change once affects all sources. The changes are saved when you turn off the projector.

### Doubler (Video / S-Video Only)

This sets double speed interpolation of the video signal.

On ..... Non-interlaced display

Off ..... Interlaced display

**NOTE:** The setting will take effect from the next video signal display.

### Last Memory

The projector stores the last signal data in memory for each input (RGB1, RGB2, RGB3, Component [YCbCr], Video 1, Video2, S-Video1, S-Video2, RGB [DIGITAL] and SDI).

This feature will reduce switching time between sources.

If a commercially available switcher is connected, turning on this feature may cause the image to appear incorrectly.

Should this happen, turn this feature off to mute the screen during switching.

Normally if this feature is turned on when the projector is used in standalone mode, switching time between sources will be short-ened.

### Seamless

This option selects modes of switching when changing input selections.

During the time of switching from one input to another, you can freeze or mute an image.

On ..... Enables the Seamless feature to freeze the image for a short period of time during input switching.

Off ..... Disables the Seamless feature to mute the image for a short period of time during input switching. This will result in no image (black screen) at the time of input switching.

### Lens Memory

This function applies the stored lens shift, focus, and zoom adjustment values to the selected signal.

The function performs a setting that enables or disables the "Adjust (Source)" - "Lens Memory" functions of the menu.

On ..... Enables the lens memory function and apply the stored shift, focus, and zoom setting values to the selected signal.

Off ..... Disables the lens memory function so that there will be no application of stored shift, focus, and zoom setting values.

**NOTE:** The shift, focus, and zoom adjustment values can be stored regardless of whether or not the lens memory function is enabled.

**NOTE:** In the Link mode the Lens Memory feature is not available.

### User Name

Type in your desired name using the INPUT buttons on the remote control.

Select one character at a time with the INPUT buttons 1 through

[Page 5]

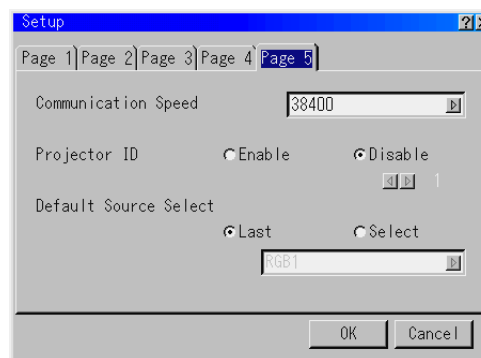

### Communication Speed

This feature sets the baud rate of the PC CONTROL connector (Mini D-Sub 9 Pin).

It supports data rates from 4800 to 38400 bps.

The default is 38400 bps. Select the appropriate baud rate for your equipment to be connected.

### Projector ID

Each projector needs its own unique addresses when used in serial communication mode. You can choose one of 64 unique address using the spin box. First select Enable. Keep pressing increases the number.

To make your setting available, select OK.

### Default Source Select

You can set the projector to default to any one of its inputs each time the projector is turned on.

Last ..... Sets the projector to default to the previous or last active input each time the projector is turned on.

Select ..... Displays the selected source input every time the projector is started up. Select an input from the pull-down menu.

### Link Mode

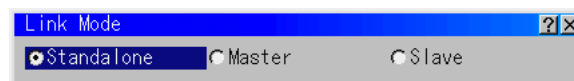

This feature is used for multiple projector connection using RGB Digital Input/Output connectors. The master projector is set to Master. The other slave projectors are set to Slave. When not using Link mode, set to Standalone. See page E-14 for setting up for double stacking in link mode.

### Switcher Control

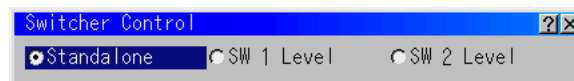

This feature sets the projector in communication with the NEC ISS-6020 Switchers.

Stand Alone ..... Use the projector in stand alone operation.

SW 1 Level ..... Use the projector with one Switcher. (not available in Link mode)

SW 2 Level ..... Use the projector with two or more Switchers. (not available in Link mode)



When changing this setting, the confirmation message will appear. If you want to restart your projector, select Yes; if not, select No.

**NOTE:** This setting becomes effective only after the projector is restarted.

## Help

Contents  
Source Information  
Projector Information

## Contents

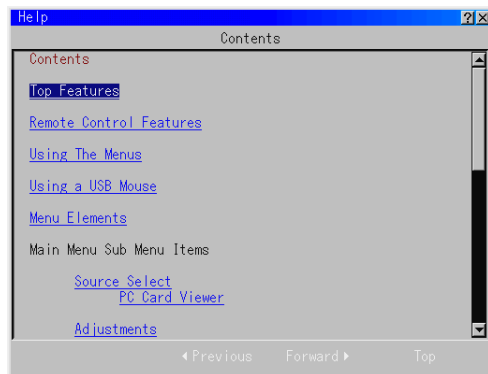

Provides an online help about how to use the menus. An underlined link means that you can move to an adjustment item directly. Selecting the underlined link and pressing ENTER moves to the corresponding adjustment item.

**NOTE:** The Help Menu may not be displayed correctly when a UXGA signal is displayed.

## Source Information

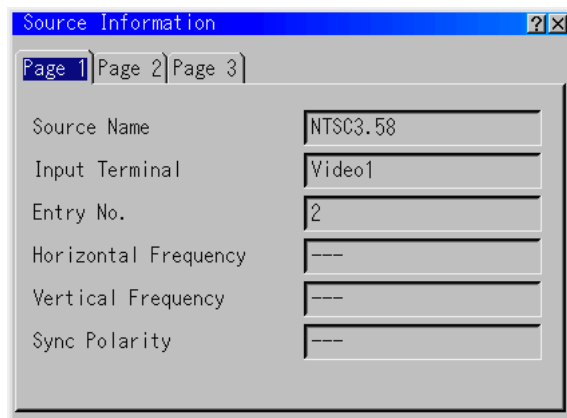

Displays the status of the current signal. This dialog box has three pages.

## Projector Information

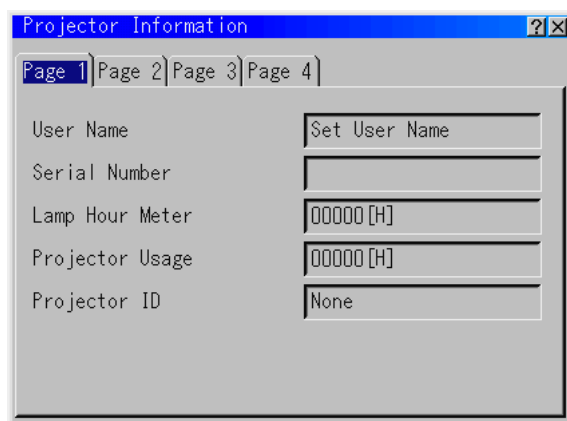

Displays the information for your projector such as lamp usage, serial number and version number etc..

[Page 4]

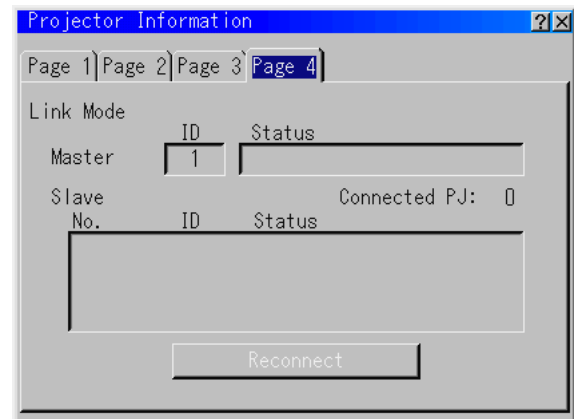

## Link Mode

Displaying Current Status of Link Mode

When selecting the tab "Page 4", you will get the following dialog box.

Master ID ..... Indicates the Master projector  
 Status ..... Indicates the status of the master projector  
 Connected PJ ..... Indicates number of connected slave projectors  
 Slave No ..... Indicates serial number of the slave projector  
 ID ..... Indicates ID of a slave projector  
 Status ..... Indicates the status of the slave projector  
 Page buttons ◀ ▶ ..... Turns pages. One screen displays information of 3 projectors only. Information of a maximum of 16 projectors can be displayed using these page buttons.

Reconnect button ..... Confirms connection of all linked projectors

Status items:

Running ..... The projector is now working  
 Cooling Lamp ..... The fan is now cooling the lamp  
 Standby ..... The projector is in stand-by  
 Communication Error . A communication error has occurred  
 Connecting ..... The projector is now verifying for connection  
 Error Standby ..... An error caused the projector to enter the stand-by mode.

## Test Pattern

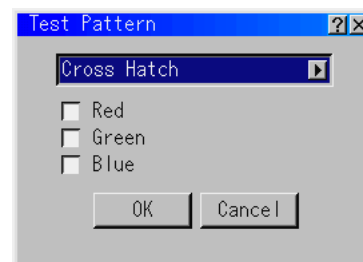

Press to display the test pattern. Pressing this button sequentially selects five test patterns.

---

## Selecting a new signal that is close to one of the listed signals in horizontal and vertical frequency

Selecting a new signal that is close to one of the listed signals in horizontal and vertical frequency may not display the image correctly because the new signal is considered as one of the registered signals listed in the Entry List. (In this case the Auto Adjust feature may not work correctly.)

To use both signals, use different input terminal (RGB 1, RGB 2 or RGB 3) respectively, or assign specific remote keys for signals.

1. Cut an existing signal from the Entry List.
  - 1) Select another signal other than the one currently projected because the currently projected signal cannot be cut.
  - 2) Press the ENTRY LIST button on the supplied remote control.
  - 3) After selecting the existing signal, press and hold down the CTL button and then the ENTER button simultaneously on the remote control. The Entry Edit Command window will appear. Select "Cut" and press the ENTER button.  
The selected signal will be deleted from the Entry List. (The signal data is stored in the clipboard.)
2. Select the new signal and enter it in the Entry List.  
Press and hold down the CTL button and then press the ENTRY LIST button simultaneously on the supplied remote control to enter the signal in the Entry List.
3. Paste the signal data that was cut and placed in the clipboard in Step 1.
  - 1) Select a vacant line in the Entry List.
  - 2) Press and hold down the CTL and then ENTER buttons simultaneously to display the Entry Edit Command window.
  - 3) Select "Paste" and press the ENTER button on the remote control to add the signal to the Entry List.
4. Assign the listed signals for direct keys respectively.
  - 1) Select the one signal in the Entry List, and press and hold down the CTL and the ENTER buttons simultaneously on the remote control to display the Entry Edit Command window.
  - 2) Select "Edit" and then press the ENTER button to display the Entry Edit screen
  - 3) Select "Direct Key" and press the ENTER button to display the Direct Key screen.
  - 4) Assign the signals for direct keys.

---

**NOTE:** Be sure not to disconnect the power cable while you are performing step 1 to 3. Failure to do so will delete the signal data stored in the clipboard. See also pages E-31 and E-32 for Entry List.

---



# 6. SPECIFICATIONS

---

## Optical

Panel *1	DMD™ .9" x 3 1280 x 1024 native resolution up to 1600 x 1200 with Advanced AccuBlend™ Technology
Lamp	2.0kW Bubble Type Short Arc Xenon Built in: Overheat Protection Lamp Over-Usage Protection
Light Output	8000 ANSI Lumens Full Light Output at 200- 240V
Brightness Uniformity	>80% edge to center
Contrast Ratio	400 : 1 Full On/Off 250 : 1 ANSI
Lens Movement	Motorized Horizontal and Vertical Lens Shift Motorized Zoom and Focus Built in Lens Shutter
Lens Options*2	TL-08SF 0.84 (Short focal lens) TL-1ZH 1.5 - 2.5 : 1 (Zoom lens) TL-2Z 2.5 - 4.0 : 1 (Zoom lens) TL-4Z 4.0 - 7.0 : 1 (Zoom lens)
Image Size	80 - 500" diagonal at 5:4

## Electrical

Scan Rate	Horizontal: 15 - 107 kHz Vertical : 24 - 105 Hz Pixel Clock 202.5MHz (MAX)
Inputs	RGB, Y/Cb/Cr, Y/Pb/Pr (2) BNC RGB H (HV), V (1) D-dub 15 pin Y/Pb/Pr, Y/Cb/Cr (1) RCA Video (1) BNC (1) RCA S-Video (1) S-Video Terminal Y/C (1) BNC Digital I/O RGB DIGITAL (1) DVI-D 24pin type TMDS specification (Max resolution : SXGA 85Hz) (1) Process Out DVI-D 24pin type SDI (Option1 for SDTV) (1) BNC SMPTE 259M Level C, 4:2:2 525/625 Component (1) BNC Through out SDI (Option2 for HDTV) (1) BNC SMPTE 292M, 4:2:2 Component 1.5Gbps Format (720p/1035i/1080i) 60Hz or 59.94Hz (1080/24sf) 48Hz or 47.95Hz PC Card (1) PCMCIA Data Back-up
Input Compatibility	NTSC, PAL, SECAM, HDTV (1080p, 1080i, 720p, 480p), VGA, SVGA, XGA, SXGA, UXGA, MAC
Video	3D Y/C Separation Telecine Detect: 3:2 pull down correction
Acceptable Sync Sys	Separate Sync/Composite Sync/ Sync on Green
Memory	100 individual memory locations
Menu System	Pull down multilingual on-screen display English/German/French/Italian/Spanish/ Swedish/Japanese
Keystone Correction	Digital through Advanced AccuBlend Technology Range 0 - ±7.5°

---

External Control	RS232C (1) D-sub 9 pin Contact Closure Switcher (2) D-sub 15 pin In/Out Addressable Remote Control (wired / wireless)
Power Requirement	200-240 VAC, 50/60Hz
Input Current	14 A
Power Consumption	2.8 kW

## Mechanical

Installation	Orientation: Desktop/Front, Desktop/Rear, Ceiling/Front, Ceiling/Rear Stacking: Up to 2 projectors can be gravity stacked
Dimensions	26.8"(W) × 40.0"(D) × 16.5"(H) with lens hood and feet (not including stacking pads and handle) 680 mm(W) × 1016 mm(D) × 420 mm(H) with lens hood and feet (not including stacking pads and handle)
Net Weight	185.3 lb (84Kg) (without lens)
Environment	Operational Temperature: 40° to 95°F / 5° to 35°C, Humidity: 20-80% non-condensing Storage Temperature: 14° to 122°F / -10° to 50°C Humidity: 20-80% non-condensing
Regulations	USA UL 1950 FCC Class A Canada CSA950 ( C-UL ) Europe EN60950 EN55022 Class A EN55024 EN61000-3-2 EN61000-3-3 Japan J60950 VCCI Oceania EN60950 AS/NZS3548 Class A Asia EN60950 CISPR22 Class A

\*1: Permissible deviation for RGB convergence (Pixel deviation) is 1/2 pixel or less at center; 3/4 pixel or less around the perimeter (when projection upward angle is 0°).

\*2: When using the zoom lens, it is recommended that the projector is positioned at an angle of from -15 to +15 degrees from the horizontal.

Specifications are subject to change without notice.

Digital Light Processing, DLP, Digital Micromirror Device and DMD are trademarks of Texas Instruments.

# 7. Optional Accessories

Lens	TL-08SF (Short Focal Lens 0.84) : 10kg TL-1ZH (Zoom Lens 1.5 - 2.5:1) : 5.5kg TL-2Z (Zoom Lens 2.5 - 4.0:1) : 4.5kg TL-4Z (Zoom Lens 4.0 - 7.0:1) : 4.5kg
Interface Board	XT SDI BOARD SX HDSDI Board
Ceiling Mount Kit	XL CMKIT
Switcher	ISS-6020 Video/RGB Switcher

A Serial Digital Interface (SDI) board is optionally available.

## XT SDI BOARD

This board accepts the input of non-compressed signal sources such as commercial type digital VTR (e.g., D1/D5-VCR) compatible with digital serial component signals (of the SMPTE 259M-C standard) and provides a high quality image without quantization noise. Note that the BNC cable used with the SDI connector should be Belden 8281 cable, or 3C-2V equivalent cable or better.

Packaged items: SDI board (1), shield case (1), connector cable (1), and installation manual (1)

## SX HDSDI Board

This board accepts the input of non-compressed signal sources such as commercial type digital VCR (D5-VCR) compatible with digital serial component signals (of the SMPTE 292M standard) and provides a high quality image without quantization noise. This board accepts the following image formats.

System	Number of samples of active 1 line	Number of active lines in 1 frame	Frame rate (Hz)	Scanning format	Sampling frequency (MHz)	Total number of samples in 1 line (dot)	Total number of lines in 1 frame
1920x1035/60/2:1	1920	1035	30	2:1Interlace	74.25	2200	1125
1920x1080/60/2:1	1920	1080	30	2:1Interlace	74.25	2200	1125
1280x720/60/1:1	1280	720	60	Progressive	74.25	1650	750
1920x1080/24(sF)	1920	1080	24	Progressive	74.25	2750	1125

Note that the BNC cable used with the HDSDI connector should be 5C-FB equivalent cable or better.

Packaged items: HDSDI board (1), shield case (1), connector cable (2), flat cable (1), set screw for shield case (2) and installation manual (1)

## REMOTE 3 (XLR) Pin Assignments and Signals

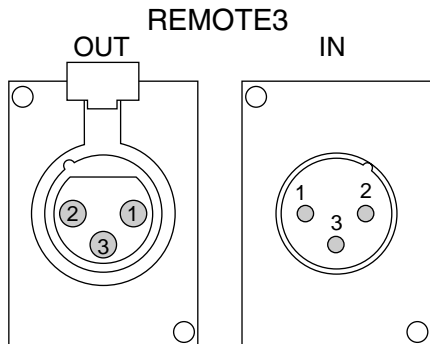

IN		OUT	
Pin No.	Signal	Pin No.	Signal
1	Ground	1	Ground
2	+3.3V	2	No connection
3	DATA IN	3	DATA OUT

**NOTE:** The wireless remote control can operate even if the plug of the remote cable is inserted into REMOTE 3 (XLR) connectors. For the wireless remote control not to operate, insert the plug of the remote cable into the REMOTE2 IN jack.

# 8. Compatible Input Signal List

## Compatible Input Signal List

Signal Name	Resolution (H×V)	Horizontal Frequency	Vertical Frequency
Video (NTSC)	640 × 480	15.734	60.0
Video (PAL/SECAM)	768 × 576	15.625	50.0
Video (HDTV)	640 × 480p	31.5	60.0
	1280 × 720p	45.0	60.0
	1920 × 1035	33.75	60.0
	1920 × 1080p	28.13	25.0
	1920 × 1080p	33.72	30.0
	1920 × 1080i	28.13	50.0
	1920 × 1080i	33.75	60.0
	1920 × 1080i	26.97	47.95
IBM PC or Compatibles	640 × 350	31.5	70.0
	640 × 400	37.9	85.0
	720 × 400	37.0	85.0
	640 × 480	31.5	60.0
	640 × 480	37.9	72.8
	640 × 480	37.5	75.0
	640 × 480	43.3	85.0
	800 × 600	35.2	56.3
	800 × 600	37.9	60.3
	800 × 600	48.1	72.0
	800 × 600	46.9	75.0
	800 × 600	53.7	85.0
	1024 × 768	48.4	60.0
	1024 × 768	56.5	70.1
	1024 × 768	60.0	75.0
	1024 × 768	68.7	85.0
	1152 × 864	67.5	75.0
	1280 × 960	60.0	60.0
	1280 × 1024	64.3	60.0
	1280 × 1024	80.0	75.0
1280 × 1024	91.1	85.0	
1600 × 1200	75.0	60.0	
1600 × 1200	81.3	65.0	
1600 × 1200	87.5	70.0	
1600 × 1200	93.8	75.0	
1600 × 1200	106.3	85.0	
Apple Macintosh	640 × 480	34.9	66.6
	832 × 624	49.7	74.6
	1024 × 768	60.2	74.9
	1152 × 870	68.7	75.6
	1280 × 1024	64.3	60.4
	1280 × 1024	74.9	69.9
HP	1280 × 1024	78.1	72.0
SUN	1152 × 900	61.8	66.0
	1280 × 1024	81.1	76.0
SGI	1024 × 768	49.7	60.4
	1152 × 900	71.7	76.1
	1280 × 1024	63.9	60.0

**NOTE 1:** The VGA, SVGA, XGA and UXGA signals are displayed with Advanced AccuBlend.

**NOTE 2:** UXGA can be supported for separate sync signal only.

**NOTE 3:** DVI digital signal can support a maximum resolution of SXGA@85Hz.

**NOTE 4:** Digital signals are indicated in shaded areas.

# 9. List of Menu Items Available in Link Mode

See the table below for available functions in the digital link mode and the analog link mode.

Function			Link mode	
Menu	Source Select		L	
	Adjust(Source)	Picture	Brightness	L
			Contrast	L
			The others	N
		White Balance		N
		Image	Pixel Adjust (Phase)	L
			Position	L
			The others	N
		Video Adj		N
		Option Adj		N
		Lens Memory		N
		Signal Type		N
	Switcher		N	
	Ref Adj	Keystone	N	
		Lamp	N	
		Ref. White Bal.	N	
	Factory Default		N	
	Projector Options	Timer	L	
		Menu	M	
		Setup	N	
		Link Mode	M	
		Switcher Control	N	
	Help		M	
Test Pattern		N		
Direct Button	LENS SHIFT	Projector	I	
		Remote Control	N	
	FOUCUS	Projector	I	
		Remote Control	I	
	ZOOM	Projector	I	
		Remote Control	I	
	MENU	Projector	L (*1)	
		Remote Control	L (*1)	
	POWER	Projector	L (*2)	
		Remote Control	L (*2)	
	POWER ON	Remote Control	L (*2)	
	POWER OFF	Remote Control	L (*2)	
	INPUT	Remote Control	L (*1)	
	MUTE(PICTURE)	Remote Control	L (*1)	
	MUTE(OSD)	Remote Control	L (*1)	
	MUTE(SOUND)	Remote Control	L (*1)	
	KEystone	Remote Control	N	
AUTO	Remote Control	N		
TEST	Remote Control	N		
PC Control	All		No restriction. Comply with the above specifications.	

\*1 Each adjustment is not possible on the slave projector in the link mode.

\*2 Each adjustment is possible on the slave projector in the link mode.

Each letter used in the above note means the following

Letter	Master projector	Slave projector (s)
L	valid	linked
N	invalid	invalid
M	valid	invalid
I	independently adjustable	independently adjustable

# Appendix

## Dimensions

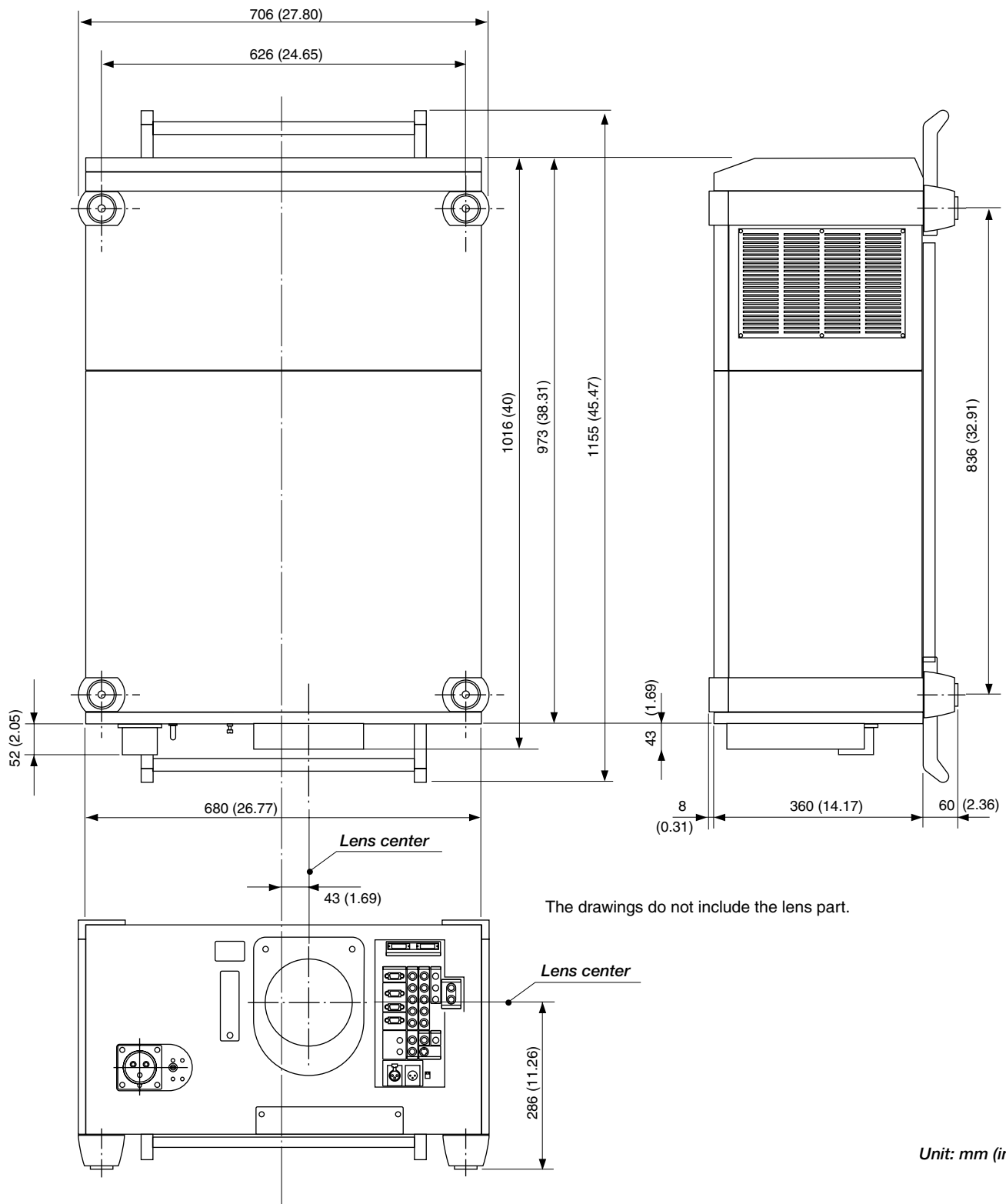

---

## Tips on Adjusting Focus for Lens Memory Function

Optimum focus for lens memory function can be achieved on the projector by paying special attention in a few areas. Focus adjustment after the projector has warmed up to normal operating temperature is better than doing so when the projector is cold. Lens mechanics interact differently when adjusting focus from one direction to the other. For this reason final focus adjustments should be done in a specific direction.

For optimum focus of lens memory function, follow the steps below. For the zoom and the lens shift adjustment, perform the normal procedures. See the "Lens Memory" section on page E-35 for storing the adjustment data.

### **Preparation (Recommend) :**

Warm up the projector for about 60 minutes.

### **Adjusting the Focus**

#### 1) Practice focusing

Use the FOCUS (+) or (-) button on the projector or the remote control to increase the focus values or decrease the focus values to verify the accuracy of focusing.

#### 2) Try optimizing defocus

Use the FOCUS button (-) to decrease the focus values until pixel patterns are too blurry to be visible.

#### 3) Obtain correct focus

Use the FOCUS button (+) to obtain the best focus. Do not use the FOCUS (-) button at this time.

Finally store the adjustments in memory.

If you adjust beyond the best focal point, go back to step 2) and repeat the procedures. Always adjust the focus from the negative direction towards the positive direction.

---

**NOTE 1:** The Lens Memory function is available on the two optional lenses TL-1ZH or TL-2Z only.

**NOTE 2:** The Lens Memory function is not available in the Link mode.

---

**NEC**